

LISTEN.  
THINK.  
SOLVE.<sup>SM</sup>

**SELECTION GUIDE**

BULLETIN 140UE  
IEC-Rated Molded Case Circuit Breakers







**Bulletin 140UE IEC Molded Case Circuit Breakers**

- 15...1250 A Molded Case Circuit Breakers
  - Thermal-Magnetic 15...800 A
  - Electronic 70...1250 A
    - LS — Long Time/Short Time
    - LSI — Long Time/Short Time/High Instantaneous
    - LSG — Long Time/Short Time/Ground Fault
    - LSIG — Long Time/Short Time/High Instantaneous/Ground Fault
  - Molded Case Switches 160...1250 A
- Factory- or field-installed accessories
- Flex cable operating mechanisms
- Rotary variable-depth operating mechanisms

**Table of Contents**

160 A, H-Frame ..... 7  
250 A, J-Frame ..... 12  
630 A, L-Frame ..... 17  
800 A, M-Frame ..... 22  
1250 A, N-Frame ..... 26

**Conformity to Standards**





IEC 60947-2

**Certifications**

CE  
KEMA-KEUR (pending)  
CCC (pending)

Bulletin 140UE  
**Molded Case Circuit Breakers**  
 Overview

Product Line Overview

											
Frame Reference		H-Frame	J-Frame	L-Frame	M-Frame	N-Frame					
Current Range		16...160 A	20...250 A	100...630 A	300...800 A	600...1250 A					
Max. Current $I_n$		160 A	250 A	630 A	800 A	1250 A					
No. of Poles		3, 4	3, 4	3, 4	3	3, 4					
Dimensions (mm)	Height	140	178	258	406	406					
	Width	76, 102	105, 140	140, 184	210	210, 280					
	Depth	76	103	104	140	140					
Interrupting Ratings: kA		$I_{cu}$	$I_{cs}$	$I_{cu}$	$I_{cs}$	$I_{cu}$	$I_{cs}$	$I_{cu}$	$I_{cs}$	$I_{cu}$	$I_{cs}$
50 Hz	220...240V	25, 35, 85, 100	50%	65, 85, 100	100%	65, 85, 100	100%	65, 100	100%	85, 200, 200	100%
	380...415V	18, 25, 40, 70	50%	20, 40, 70	100%	25, 50, 70	100%	50, 70	100%	50, 70, 100	100%
	690V	6, 6, 7, 8	50%	6, 6, 7, 8	50%	2, 20, 25	50%	20, 25	100%	20, 35, 50	50%
60 Hz NEMA	220...240V	65, 85, 100		65, 85, 100, 200		65, 85, 100		65, 100		65, 100, 200	
	480V	25, 35, 65		25, 35, 65		35, 50, 65		50, 65		50, 65, 100	
	600V	18, 18, 25		18, 18, 25, 35		100, 65, 35		25, 35		25, 35, 50	
Protection Type											
Thermal-Magnetic		FF, AF	AA	AA	AA	AF	—				
Electronic		—	✓	✓	✓	✓	✓				
Disconnecter		✓	✓	✓	✓	✓	✓				
Internal Accessories											
Alarm (Trip) Contacts		✓	✓	✓	✓	✓	✓				
Auxiliary Shields		✓	✓	✓	✓	✓	✓				
Aux/Alarm Combination		✓	✓	✓	✓	✓	✓				
Shunt Trip		✓	✓	✓	✓	✓	✓				
Undervoltage Release		✓	✓	✓	✓	✓	✓				
Field Installable		✓	✓	✓	✓	✓	✓				
External Accessories											
Padlockable Hasp		✓	✓	✓	✓	✓	✓				
Terminal Covers		✓	✓	✓	✓	✓	✓				
Terminal Lugs		Standard	Standard	Standard	Standard	Standard	Standard				
End Cap Kits		✓	✓	✓	✓	✓	—				
Flex-Cable Operating Mech.		✓	✓	✓	✓	✓	✓				
Variable Depth Rotary Operating Mechanism		✓	✓	✓	✓	✓	✓				
Direct Coupler Rotary Operating Mechanism		✓	✓	✓	✓	—	—				
Phase Barriers		✓	✓	✓	✓	✓	✓				
Plug-in Base		✓	✓	✓	✓	—	—				
Slide Bar Interlock		✓	✓	✓	✓	✓	✓				
Standards Compliance											
IEC 60947-2		✓	✓	✓	✓	✓	✓				
CE		✓	✓	✓	✓	✓	✓				
KEMA-KEUR		✓	✓	✓	✓	✓	✓				

**Catalog Number Explanation**

Examples given in this section are for reference purposes only. This basic explanation should not be used for product selection; not all combinations will produce a valid cat. no. Refer to the tables on the following pages for descriptions of options.

**Complete Circuit Breaker Assemblies**

140 UE - J 7 E 3 - D15  
           *a*      *b*      *c*      *d*      *e*      *f*

*a*

Bulletin No.	
Code	Description
UE	IEC Molded Case Circuit Breaker

*b*

Frame/Rating	
Code	Description
H	160 A
J	250 A
L	630 A
M	800 A
N	1250 A

*c*

Interrupting Rating/Breaking Capacity (based on I <sub>c</sub> at 400V)	
Code	Description
1	10...19 kA
2	20...29 kA
3	30...39 kA
4	40...49 kA
5	50...59 kA
6	60...69 kA
7	70...79 kA
8	80...89 kA
0	≥100 kA

*d*

Protection Type	
Code	Description
C	Fixed Thermal/Fixed Magnetic
D	Fixed Thermal/Adjust Magnetic
E	Adjust Thermal/Fixed Magnetic
F	Adjust Thermal/Adjust Magnetic
G	Electronic (LSG — Long, short, ground fault)
H	Electronic (LSI — Long, short, high instant)
I	Electronic (LSIG — Long, short, high instant, ground fault)
L	Electronic (LS — Long and Short time)
S	Molded Case Switch (Isolator)

*e*

Poles	
Code	Description
3	3 poles
4	4 poles

*f*

Current Range	
Code	Description
C	C = 1x [ex. C = 15 A]
D	D = 10x [ex. D = 150 A]
E	E = 100x [ex. E = 1500 A]

Bulletin 140UE  
**Molded Case Circuit Breakers**  
 Catalog Number Explanation

Examples given in this section are for reference purposes only. This basic explanation should not be used for product selection; not all combinations will produce a valid cat. no. Refer to the tables on the following pages for descriptions of options.

Frames

140 UE - J 7 X 3  
*a* *b* *c* *d* *e*

*a*

Bulletin No.	
Code	Description
UE	IEC Molded Case Circuit Breaker

*c*

Interrupting Rating/Breaking Capacity (based on I <sub>c</sub> at 400V)	
Code	Description
1	10...19 kA
2	20...29 kA
3	30...39 kA
4	40...49 kA
5	50...59 kA
6	60...69 kA
7	70...79 kA
8	80...89 kA
0	≥100 kA

*d*

Protection Type	
Code	Description
X	Frame Only

*b*

Frame/Rating	
Code	Description
J	250 A
L	630 A
M	800 A

*e*

Poles	
Code	Description
3	3 poles
4	4 poles

Trip Units

140 UE - J T D 3 - D25  
*a* *b* *c* *d* *e* *f*

*a*

Bulletin No.	
Code	Description
UE	IEC Molded Case Circuit Breaker

*c*

Trip Unit	
Code	Description
T	Trip Unit

*e*

Poles	
Code	Description
3	3 poles
4	4 poles

*b*

Frame/Rating	
Code	Description
J	250 A
L	630 A
M	800 A

*d*

Protection Type	
Code	Description
C	Fixed Thermal/Fixed Magnetic
D	Fixed Thermal/Adjust Magnetic
E	Adjust Thermal/Fixed Magnetic
F	Adjust Thermal/Adjust Magnetic
G	Electronic (LSG — Long, short, ground fault)
H	Electronic (LSI — Long, short, high instant)
I	Electronic (LSIG — Long, short, high instant, ground fault)
L	Electronic (LS — Long and Short time)
S	Molded Case Switch (isolator)

*f*

Current Range	
Code	Description
C	C=1x [ex. C = 25 A]
D	D=10x [ex. D = 150 A]
E	E=100x [ex. E = 1500 A]



**160 A, H-Frame**

- IEC 60947-2
- CE
- KEMA-KEUR

**Note:** Terminal box lugs and mounting hardware provided as standard

**18 kA, Thermal-Magnetic, Fixed Thermal-Fixed Magnetic**

Rated Current $I_n$	Thermal Trip [A] $I_r = I_n$	Magnetic Trip [A] $I_m = 10 \times I_n$	Breaking Capacity (50 Hz) $I_{cu} // I_{cs}$ [kA]								NEMA Interrupt Rating (60 Hz) [kA]			Cat. No.	
			220...240V		380...415V		500V		690V		240V	480V	600/347V	3-Pole	4-Pole
16 A	16	500	25	13	18	9	—	—	—	—	25	14	10	140UE-H1C3-C16	—
20 A	20	500	25	13	18	9	—	—	—	—	25	14	10	140UE-H1C3-C20	—
25 A	25	500	25	13	18	9	—	—	—	—	25	14	10	140UE-H1C3-C25	—
32 A	32	500	25	13	18	9	—	—	—	—	25	14	10	140UE-H1C3-C32	—
40 A	40	500	25	13	18	9	—	—	—	—	25	14	10	140UE-H1C3-C40	—
50 A	50	500	25	13	18	9	—	—	—	—	25	14	10	140UE-H1C3-C50	—
63 A	63	630	25	13	18	9	—	—	—	—	25	14	10	140UE-H1C3-C63	—
80 A	80	860	25	13	18	9	—	—	—	—	25	14	10	140UE-H1C3-C80	—
100 A	100	1000	25	13	18	9	—	—	—	—	25	14	10	140UE-H1C3-D10	—
125 A	125	1250	25	13	18	9	—	—	—	—	25	14	10	140UE-H1C3-D12	—
160 A	160	1600	25	13	18	9	—	—	—	—	25	14	10	140UE-H1C3-D16	—

**18 kA, Thermal-Magnetic, Adjustable Thermal-Fixed Magnetic**

Rated Current $I_n$	Thermal Trip [A] $I_r = 0.8...1.0 \times I_n$	Magnetic Trip [A] $I_m = 10 \times I_n$	Breaking Capacity (50 Hz) $I_{cu} // I_{cs}$ [kA]								NEMA Interrupt Rating (60 Hz) [kA]			Cat. No.	
			220...240V		380...415V		500V		690V		240V	480V	600/347V	3-Pole	4-Pole
20 A	16...20	500	25	13	16	9	—	—	—	—	25	14	10	140UE-H1E3-C20	140UE-H1E4-C20
25 A	20...25	500	25	13	16	9	—	—	—	—	25	14	10	140UE-H1E3-C25	140UE-H1E4-C25
32 A	25...32	500	25	13	16	9	—	—	—	—	25	14	10	140UE-H1E3-C32	140UE-H1E4-C32
40 A	32...40	500	25	13	16	9	—	—	—	—	25	14	10	140UE-H1E3-C40	140UE-H1E4-C40
50 A	40...50	500	25	13	16	9	—	—	—	—	25	14	10	140UE-H1E3-C50	140UE-H1E4-C50
63 A	50...63	630	25	13	16	9	—	—	—	—	25	14	10	140UE-H1E3-C63	140UE-H1E4-C63
80 A	—	800	25	13	16	9	—	—	—	—	25	14	10	140UE-H1E3-C80	140UE-H1E4-C80
100 A	—	1000	25	13	16	9	—	—	—	—	25	14	10	140UE-H1E3-D10	140UE-H1E4-D10
125 A	—	1250	25	13	16	9	—	—	—	—	25	14	10	140UE-H1E3-D12	140UE-H1E4-D12
160 A	—	1600	25	13	16	9	—	—	—	—	25	14	10	140UE-H1E3-D16	140UE-H1E4-D16

**25 kA, Thermal-Magnetic, Adjustable Thermal-Fixed Magnetic**

Rated Current $I_n$	Thermal Trip [A] $I_r = 0.8...1.0 \times I_n$	Magnetic Trip [A] $I_m = 10 \times I_n$	Breaking Capacity (50 Hz) $I_{cu} // I_{cs}$ [kA]								NEMA Interrupt Rating (60 Hz) [kA]			Cat. No.	
			220...240V		380...415V		500V		690V		240V	480V	600/347V	3-Pole	4-Pole
20 A	16...20	500	35	18	25	13	—	—	—	—	35	22	10	140UE-H2E3-C20	140UE-H2E4-C20
25 A	20...25	500	35	18	25	13	—	—	—	—	35	22	10	140UE-H2E3-C25	140UE-H2E4-C25
32 A	25...32	500	35	18	25	13	—	—	—	—	35	22	10	140UE-H2E3-C32	140UE-H2E4-C32
40 A	32...40	500	35	18	25	13	—	—	—	—	35	22	10	140UE-H2E3-C40	140UE-H2E4-C40
50 A	40...50	500	35	18	25	13	—	—	—	—	35	22	10	140UE-H2E3-C50	140UE-H2E4-C50
63 A	50...63	630	35	18	25	13	—	—	—	—	35	22	10	140UE-H2E3-C63	140UE-H2E4-C63
80 A	63...80	800	35	18	25	13	—	—	—	—	35	22	10	140UE-H2E3-C80	140UE-H2E4-C80
100 A	80...100	1000	35	18	25	13	—	—	—	—	35	22	10	140UE-H2E3-D10	140UE-H2E4-D10
125 A	100...125	1250	35	18	25	13	—	—	—	—	35	22	10	140UE-H2E3-D12	140UE-H2E4-D12
160 A	125...160	1600	35	18	25	13	—	—	—	—	35	22	10	140UE-H2E3-D16	140UE-H2E4-D16

# Molded Case Circuit Breakers

Product Selection — 160 A, H-Frame, Continued

## 40 kA, Thermal-Magnetic, Adjustable Thermal-Fixed Magnetic

Rated Current $I_n$	Thermal Trip [A] $I_r = 0.8...1.0 \times I_n$	Magnetic Trip [A] $I_m = 10 \times I_n$	Breaking Capacity (50 Hz) $I_{cu} // I_{cs}$ [kA]								NEMA Interrupt Rating (60 Hz) [kA]			Cat. No.	
			220...240V		380...415V		500V		690V		240V	480V	600/347V	3-Pole	4-Pole
20 A	16...20	500	85	43	40	30	25	18	4	3	85	35	22	140UE-H4E3-C20	140UE-H4E4-C20
25 A	20...25	500	85	43	40	30	25	18	4	3	85	35	22	140UE-H4E3-C25	140UE-H4E4-C25
32 A	25...32	500	85	43	40	30	25	18	4	3	85	35	22	140UE-H4E3-C32	140UE-H4E4-C32
40 A	32...40	500	85	43	40	30	25	18	4	3	85	35	22	140UE-H4E3-C40	140UE-H4E4-C40
50 A	40...50	500	85	43	40	30	25	18	4	3	85	35	22	140UE-H4E3-C50	140UE-H4E4-C50
63 A	50...63	630	85	43	40	30	25	18	4	3	85	35	22	140UE-H4E3-C63	140UE-H4E4-C63
80 A	63...80	800	85	43	40	30	25	18	4	3	85	35	22	140UE-H4E3-C80	140UE-H4E4-C80
100 A	80...100	1000	85	43	40	30	25	18	4	3	85	35	22	140UE-H4E3-D10	140UE-H4E4-D10
125 A	100...125	1250	85	43	40	30	25	18	4	3	85	35	22	140UE-H4E3-D12	140UE-H4E4-D12







## 70 kA, Thermal-Magnetic, Adjustable Thermal-Fixed Magnetic

Rated Current $I_n$	Thermal Trip [A] $I_r = 0.8...1.0 \times I_n$	Magnetic Trip [A] $I_m = 10 \times I_n$	Breaking Capacity (50 Hz) $I_{cu} // I_{cs}$ [kA]								NEMA Interrupt Rating (60 Hz) [kA]			Cat. No.	
			220...240V		380...415V		500V		690V		240V	480V	600/347V	3-Pole	4-Pole
20 A	16...20	500	100	50	70	35	35	18	6	3	100	65	25	140UE-H7E3-C20	140UE-H7E4-C20
25 A	20...25	500	100	50	70	35	35	18	6	3	100	65	25	140UE-H7E3-C25	140UE-H7E4-C25
30 A	25...32	500	100	50	70	35	35	18	6	3	100	65	25	140UE-H7E3-C32	140UE-H7E4-C32
40 A	32...40	500	100	50	70	35	35	18	6	3	100	65	25	140UE-H7E3-C40	140UE-H7E4-C40
50 A	40...50	500	100	50	70	35	35	18	6	3	100	65	25	140UE-H7E3-C50	140UE-H7E4-C50
63 A	50...63	630	100	50	70	35	35	18	6	3	100	65	25	140UE-H7E3-C63	140UE-H7E4-C63
80 A	63...80	800	100	50	70	35	35	18	6	3	100	65	25	140UE-H7E3-C80	140UE-H7E4-C80
100 A	80...100	1000	100	50	70	35	35	18	6	3	100	65	25	140UE-H7E3-D10	140UE-H7E4-D10
125 A	100...125	1250	100	50	70	35	35	18	6	3	100	65	25	140UE-H7E3-D12	140UE-H7E4-D12

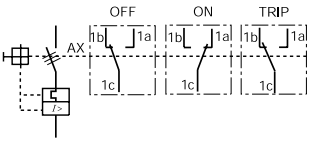
## Isolation Disconnecter — IEC 60947-3

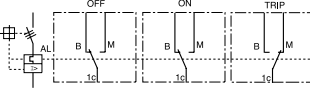
Rated Current $I_n$	Thermal Trip [A] $I_r = I_n$ (Fixed)	Magnetic Trip [A] $I_m = 10 \times I_n$	Breaking Capacity (50 Hz) $I_{cu} // I_{cs}$ [kA]						NEMA Interrupt Rating (60 Hz) [kA]			Cat. No.			
			220...240V		380...415V		500V		690V		240V	480V	600/347V	3-Pole	4-Pole
160 A	—	1600	35	18	25	25	—	—	3	3	25	25	—	140UE-H2S3-D16	140UE-H2S4-D16

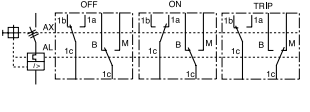
**Internal Control Modules — Field Installed**

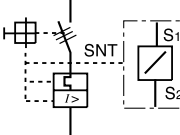
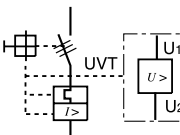
	Description	Mounting Location	Diagram	Cat. No.
	<b>Auxiliary Contact (AX)</b> Electrically indicates "ON/OFF" status of breakers	(1) 1a-1b		140U-H-EA1
		(2) 1a-1b		Right Side Only
	<b>Alarm Contact (AL)</b> Electrically indicates when the breaker is in the "TRIPPED" state	(1) 1M (make)-1B (break)		140U-H-ER1
				Right Side Only
	<b>Auxiliary/Alarm Contact (AX/AL) Combination</b> Combination of auxiliary contact and alarm contact	(1) 1a-1b (1) 1M (make)-1B (break)		140U-H-EA1R1
	<b>Shunt Trip (SNT)</b> Provides remote tripping of the circuit breaker Undervoltage trip not available when shunt trip is used	24...60V, 50/60/DC		140U-H-SNJ
		110...240V, 50/60/DC		140U-H-SND
		380...600V, 50/60 Hz		140U-H-SNB
	<b>Undervoltage Release (UVT)</b> Automatically trips breaker when voltage falls between preset value, 35...70% Shunt trip is not available when undervoltage release is used	24V, 50/60/DC		140U-H-UJ
		110...127V, 50/60 Hz		140U-H-UD
208...240V, 50/60 Hz		140U-H-UA		
	380...500V, 50/60 Hz	140U-H-UB		
	525...600V, 50/60 Hz	Left Side Only	140U-H-UC	

**Internal Control Modules — Factory Installed**

*Left side only*

- (1) Shunt Trip (SNT)  
or
- (1) Undervoltage Release (UVT)

**Mounting Location**

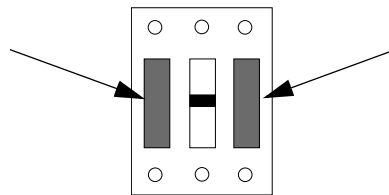

*Right side only*

- (1) Auxiliary contact (AX)  
or
- (2) Auxiliary contacts (AX)  
or
- (1) Alarm contact (AL)  
or
- (1) Alarm contact (AL) + Auxiliary contact (AX)

Auxiliary and Alarm Contacts	Suffix
(1) AX	- A
(2) AX	- B
(1) AL	- D
(1) AX + (1) AL	- F

Shunt Trip Combinations	Suffix
(1) SNT only	- P⊗
(1) AX + (1) SNT	- Q⊗
(2) AX + (1) SNT	- R⊗
(1) AX + (1) AL + (1) SNT	- T⊗
(1) AL + (1) SNT	- V⊗

Undervoltage Release Combinations	Suffix
(1) UVT only	- G⊗
(1) AX + (1) UVT	- H⊗
(2) AX + (1) UVT	- J⊗
(1) AX + (1) AL + (1) UVT	- L⊗
(1) AL + (1) UVT	- N⊗

⊗Standard Voltage Suffix Codes\*

Voltage [V]	24...60	110...240	380...600
AC, 50/60 Hz	J	D	B
DC	J	D	—

⊗Standard Voltage Suffix Codes\*







Voltage [V]	24	110...127	208...240	380...500	525...600
AC, 50/60 Hz	J	D	A	B	C
DC	J	—	—	—	—

\* For additional voltages, consult your local Allen-Bradley distributor.







# Molded Case Circuit Breakers

Accessories — 160 A, H-Frame, Continued

## External Accessories

	Description	For Use With	Cat. No.
	<b>Terminal End Cover</b> 6.4 mm (0.25 in.) Diameter Cable Entry	Qty: 1	3-Pole MCCBs <a href="#">140U-H-TC2</a>
	<b>Terminal End Cover</b> 10.4 mm (0.41 in.) Diameter Cable Entry		3-Pole MCCBs <a href="#">140U-H-TC4</a>
			4-Pole MCCBs <a href="#">140U-H-TC44</a>
	<b>Terminal Shields</b> IP20 Ingress Protection Rating	Qty: 1	3-Pole MCCBs <a href="#">140U-H-TS</a>
		Qty: 1	4-Pole MCCBs <a href="#">140U-H-TS4</a>
	<b>Rotary, Variable-Depth Operating Mechanism</b> Rotary Handle - IP66, UL Type 3/12/4/4X	Black Handle 12 in.(30.5 cm)Shaft	<a href="#">140U-H-RVM12B</a>
		Red/Yellow Handle 12 in.(30.5 cm)Shaft	<a href="#">140U-H-RVM12R</a>
		Black Handle 21 in.(53.4 cm)Shaft	<a href="#">140U-H-RVM21B</a>
		Red/Yellow Handle 21 in.(53.4 cm)Shaft	<a href="#">140U-H-RVM21R</a>
	<b>Flex-Cable Operating Mechanism</b> Includes handle, cable, operating, and bail mechanism Pre-assembled and adjusted Non-Metallic - UL IP66, Type 1/3/12/4/4X Flange Mount Operating Handle	1.5 ft. (0.46 m) Cable	<a href="#">140U-H-FCX01</a>
		3 ft. (0.91 m) Cable	<a href="#">140U-H-FCX03</a>
		4 ft. (1.2 m) Cable	<a href="#">140U-H-FCX04</a>
		6 ft. (1.8 m) Cable	<a href="#">140U-H-FCX06</a>
		10 ft. (3 m) Cable	<a href="#">140U-H-FCX10</a>
	<b>Rotary, Direct Couple Operating Mechanism</b> Rotary Handle - IP42 UL Type 1 Breaker Mounted	Black Handle	<a href="#">140U-H-RCB</a>
		Red/Yellow Handle	<a href="#">140U-H-RCR</a>
	<b>End Cap Kit</b> Provides connections for terminal or bolt-on connections Metric Hardware Provided	Qty: 1	3-Pole MCCBs <a href="#">140U-H-ECM</a>
		Qty: 1	4-Pole MCCBs <a href="#">140U-H-ECM4</a>
 <p>Cat. No. 140U-H-MTL3AN</p>	<b>Multi-Tap Terminal Lugs</b> (3) #14...#2 AWG (3) 2.5...35 mm <sup>2</sup>	Qty: 3	3-Pole MCCBs <a href="#">140U-H-MTL3AN</a>
	<b>Multi-Tap Terminal Lugs</b> (6) #14...#6 AWG (6) 2.5...10 mm <sup>2</sup>	Qty: 3	3-Pole MCCBs <a href="#">140U-H-MTL6AN</a>
	<b>Multi-Tap Terminal Lug Kit —</b> with IP20 terminal cover (3) #14...#2 AWG (3) 2.5...35 mm <sup>2</sup>	Qty: 3 with terminal shield	3-Pole MCCBs <a href="#">140U-H-MTL3A</a>
	<b>Multi-Tap Terminal Lug Kit —</b> with IP20 terminal cover (6) #14...#6 AWG (6) 2.5...10 mm <sup>2</sup>	Qty: 3 with terminal shield	3-Pole MCCBs <a href="#">140U-H-MTL6A</a>
	<b>Multi-Tap Terminal Lugs —</b> with IP20 terminal cover (3) #14...#2 AWG (3) 2.5...35 mm <sup>2</sup>	Qty: 4	4-Pole MCCBs <a href="#">140U-H-MTL3A4</a>
	<b>Multi-Tap Terminal Lugs —</b> with IP20 terminal cover (6) #14...#6 AWG (6) 2.5...10 mm <sup>2</sup>	Qty: 4	4-Pole MCCBs <a href="#">140U-H-MTL6A4</a>

External Accessories, Continued

	Description		For Use With	Cat. No.
	<b>Phase Barriers</b> Provides additional phase clearance when special connections that extend past the circuit breaker housing are required	Qty: 2	3-Pole MCCBs	<a href="#">140U-H-PB</a>
		Qty: 3	4-Pole MCCBs	<a href="#">140U-H-PB4</a>
	<b>Padlock Kit</b> Padlocking Hasp Lock-OFF only	Qty: 1	3- or 4-Pole MCCBs	<a href="#">140U-H-PL</a>
	<b>DIN Rail Adapter</b> Allows H-frame MCCB to mount to 35 mm DIN Rail	Qty: 1	3- or 4-Pole MCCBs	<a href="#">140U-H-DRA</a>
	<b>Plug-in Base Adapters</b> Plug-in provides power terminations and adapter	Qty: 1	3-Pole MCCBs	<a href="#">140U-H-PAD3</a>
			4-Pole MCCBs	<a href="#">140U-H-PAD4</a>
	<b>Plug-in Base Auxiliary Contacts</b> Provides auxiliary contact functions to detect breaker installation status	Qty: 1	3- or 4-Pole MCCBs	<a href="#">140U-H-PDK</a>
	<b>Mounting Hardware</b> (4) M4 - 0.7 x 75 mm	Qty: 1	3- or 4-Pole MCCBs	<a href="#">140U-H-MHM</a>
	<b>Motor Operator</b> Remotely opens, closes, and resets the circuit breaker	Qty: 1	3- or 4-Pole MCCBs, 110...240V AC/DC	<a href="#">140U-H-EOPD</a>
			3- or 4-Pole MCCBs, 24V DC	<a href="#">140U-H-EOPZ</a>
	<b>Slide Bar Interlock</b>	Qty: 1	—	<a href="#">140U-H-SBLK</a>

Bulletin 140UE  
**Molded Case Circuit Breakers**  
 Product Selection — 250 A, J Frame

**250 A, J-Frame**

- IEC 60947-2
- CE
- KEMA-KEUR

**Note: Terminal box lugs and mounting hardware included.**

Circuit breakers can be assembled from a circuit breaker frame and a trip unit, or purchased as assembled units.

Example:

Cat. No. **140UE-J2X3** (frame) + Cat. No. **140UE-JTF3-C80** (trip unit) = Cat. No. **140UE-J2F3-C80** (equivalent assembled circuit breaker)



**Breaker Frames**

Rated Current $I_n$ [A]	Breaking Capacity (50 Hz) $I_{cu} / I_{cs}$ [kA]								NEMA Interrupt Rating (60 Hz) [kA]			Cat. No.	
	220...240V		380...415V		500V		690V		240V	480V	600V	3-Pole	4-Pole
	250 A	65	65	25	25	20	12	12	6	65	25	18	140UE-J2X3
	85	85	40	40	35	20	12	6	85	35	18	140UE-J4X3	140UE-J4X4
	100	100	70	70	42	20	14	7	100	65	25	140UE-J7X3	140UE-J7X4

**Trip Units, Thermal-Magnetic**

Rated Operational Current $I_n$	Adjustment Range [A]		Protection Type	Cat. No.	
	Thermal Trip Adjustment Range $I_r = 0.8...1.0 I_n$	Magnetic Trip $I_m = 5...10 \times I_n$		3-Pole	4-Pole *
80 A	64...80	400...800	AA	140UE-JTF3-C80	140UE-JTF4-C80
100 A	80...100	500...1000	AA	140UE-JTF3-D10	140UE-JTF4-D10
125 A	100...125	625...1250	AA	140UE-JTF3-D12	140UE-JTF4-D12
160 A	128...160	800...1600	AA	140UE-JTF3-D16	140UE-JTF4-D16
200 A	160...200	1000...2000	AA	140UE-JTF3-D20	140UE-JTF4-D20
250 A	200...250	1250...2500	AA	140UE-JTF3-D25	140UE-JTF4-D25

\* 4th pole neutral — 0/100% protected

**Trip Units, Electronic**

Rated Operational Current $I_n$	Adjustment Range [A]		Protection Type*	Ground Fault Functions		Cat. No.	
	Thermal Trip $I_r = 0.4...1.0 \times I_n$	Magnetic Trip $I_m = 2...10 \times I_n$		$I_G=0.2...1.0 I_N$	$T_G=ms$	3-Pole	4-Pole
50 A	20...50	40...700	LS	—	—	140UE-JTL3-C50	140UE-JTL4-C50
50 A	20...50	40...700	LSI	—	—	140UE-JTH3-C50	140UE-JTH4-C50
50 A	20...50	40...700	LSG	10...50	Inst., 120, 300	140UE-JTG3-C50	140UE-JTG4-C50
50 A	20...50	40...700	LSIG	10...50	Inst., 120, 300	140UE-JTI3-C50	140UE-JTI4-C50
100 A	40...100	80...1400	LS	—	—	140UE-JTL3-D10	140UE-JTL4-D10
100 A	40...100	80...1400	LSI	—	—	140UE-JTH3-D10	140UE-JTH4-D10
100 A	40...100	80...1400	LSG	20...100	Inst., 120, 300	140UE-JTG3-D10	140UE-JTG4-D10
100 A	40...100	80...1400	LSIG	20...100	Inst., 120, 300	140UE-JTI3-D10	140UE-JTI4-D10
160 A	63...160	126...2240	LS	—	—	140UE-JTL3-D16	140UE-JTL4-D16
160 A	63...160	126...2240	LSI	—	—	140UE-JTH3-D16	140UE-JTH4-D16
160 A	63...160	126...2240	LSG	32...160	Inst., 120, 300	140UE-JTG3-D16	140UE-JTG4-D16
160 A	63...160	126...2240	LSIG	32...160	Inst., 120, 300	140UE-JTI3-D16	140UE-JTI4-D16
250 A	100...250	200...3500	LS	—	—	140UE-JTL3-D25	140UE-JTL4-D25
250 A	100...250	200...3500	LSI	—	—	140UE-JTH3-D25	140UE-JTH4-D25
250 A	100...250	200...3500	LSG	50...250	Inst., 120, 300	140UE-JTG3-D25	140UE-JTG4-D25
250 A	100...250	200...3500	LSIG	50...250	Inst., 120, 300	140UE-JTI3-D25	140UE-JTI4-D25

Adjustable long-time delay: 2...24s @ 6 times  $I_r$   
 Adjustable short-time delay: Inst., 120 ms, 300 ms

## Molded Case Circuit Breakers

Product Selection — 250 A, J Frame, Continued

### Assembled Circuit Breakers, Thermal-Magnetic Trip Units

Rated Operational Current $I_n$	Protection Type $I_n$	Breaking Capacity 380...415V (50 Hz)					
		3 Poles			4 Poles		
		25 kA Cat. No.	40 kA Cat. No.	70 kA Cat. No.	25 kA Cat. No.	40 kA Cat. No.	70 kA Cat. No.
80 A	AA	140UE-J2F3-C80	140UE-J4F3-C80	140UE-J7F3-C80	140UE-J2F4-C80	140UE-J4F4-C80	140UE-J7F4-C80
100 A	AA	140UE-J2F3-D10	140UE-J4F3-D10	140UE-J7F3-D10	140UE-J2F4-D10	140UE-J4F4-D10	140UE-J7F4-D10
125 A	AA	140UE-J2F3-D12	140UE-J4F3-D12	140UE-J7F3-D12	140UE-J2F4-D12	140UE-J4F4-D12	140UE-J7F4-D12
160 A	AA	140UE-J2F3-D16	140UE-J4F3-D16	140UE-J7F3-D16	140UE-J2F4-D16	140UE-J4F4-D16	140UE-J7F4-D16
200 A	AA	140UE-J2F3-D20	140UE-J4F3-D20	140UE-J7F3-D20	140UE-J2F4-D20	140UE-J4F4-D20	140UE-J7F4-D20
250 A	AA	140UE-J2F3-D25	140UE-J4F3-D25	140UE-J7F3-D25	140UE-J2F4-D25	140UE-J4F4-D25	140UE-J7F4-D25







### Assembled Circuit Breakers, Electronic Trip Units

Rated Operational Current $I_n$	Protection Type	Breaking Capacity 380...415V (50 Hz)					
		3 Poles			4 Poles		
		25 kA Cat. No.	40 kA Cat. No.	70 kA Cat. No.	25 kA Cat. No.	40 kA Cat. No.	70 kA Cat. No.
50 A	LS	140UE-J2L3-C50	140UE-J4L3-C50	140UE-J7L3-C50	140UE-J2L4-C50	140UE-J4L4-C50	140UE-J7L4-C50
50 A	LSI	140UE-J2H3-C50	140UE-J4H3-C50	140UE-J7H3-C50	140UE-J2H4-C50	140UE-J4H4-C50	140UE-J7H4-C50
50 A	LSG	140UE-J2G3-C50	140UE-J4G3-C50	140UE-J7G3-C50	140UE-J2G4-C50	140UE-J4G4-C50	140UE-J7G4-C50
50 A	LSIG	140UE-J2I3-C50	140UE-J4I3-C50	140UE-J7I3-C50	140UE-J2I4-C50	140UE-J4I4-C50	140UE-J7I4-C50
100 A	LS	140UE-J2L3-D10	140UE-J4L3-D10	140UE-J7L3-D10	140UE-J2L4-D10	140UE-J4L4-D10	140UE-J7L4-D10
100 A	LSI	140UE-J2H3-D10	140UE-J4H3-D10	140UE-J7H3-D10	140UE-J2H4-D10	140UE-J4H4-D10	140UE-J7H4-D10
100 A	LSIG	140UE-J2G3-D10	140UE-J4G3-D10	140UE-J7G3-D10	140UE-J2G4-D10	140UE-J4G4-D10	140UE-J7G4-D10
100 A	LSIG	140UE-J2I3-D10	140UE-J4I3-D10	140UE-J7I3-D10	140UE-J2I4-D10	140UE-J4I4-D10	140UE-J7I4-D10
160 A	LS	140UE-J2L3-D16	140UE-J4L3-D16	140UE-J7L3-D16	140UE-J2L4-D16	140UE-J4L4-D16	140UE-J7L4-D16
160 A	LSI	140UE-J2H3-D16	140UE-J4H3-D16	140UE-J7H3-D16	140UE-J2H4-D16	140UE-J4H4-D16	140UE-J7H4-D16
160 A	LSG	140UE-J2G3-D16	140UE-J4G3-D16	140UE-J7G3-D16	140UE-J2G4-D16	140UE-J4G4-D16	140UE-J7G4-D16
160 A	LSIG	140UE-J2I3-D16	140UE-J4I3-D16	140UE-J7I3-D16	140UE-J2I4-D16	140UE-J4I4-D16	140UE-J7I4-D16
250 A	LS	140UE-J2L3-D25	140UE-J4L3-D25	140UE-J7L3-D25	140UE-J2L4-D25	140UE-J4L4-D25	140UE-J7L4-D25
250 A	LSI	140UE-J2H3-D25	140UE-J4H3-D25	140UE-J7H3-D25	140UE-J2H4-D25	140UE-J4H4-D25	140UE-J7H4-D25
250 A	LSG	140UE-J2G3-D25	140UE-J4G3-D25	140UE-J7G3-D25	140UE-J2G4-D25	140UE-J4G4-D25	140UE-J7G4-D25
250 A	LSIG	140UE-J2I3-D25	140UE-J4I3-D25	140UE-J7I3-D25	140UE-J2I4-D25	140UE-J4I4-D25	140UE-J7I4-D25

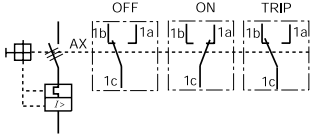
### Isolation Disconnecter — IEC 60947-3

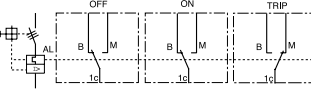
Rated Current $I_n$ [A]	Thermal Trip $I_t = I_n$ [A]	Magnetic Trip [A] $I_m = 10 \times I_n$	Breaking Capacity (50 Hz) $I_{cu} // I_{cs}$ [kA]								Interrupting Rating (60 Hz) [kA]			Cat. No.	
			220...240V		380...415V		500V		690V		240V	480V	600V	3-Pole	4-Pole
250 A	—	2500	100	100	70	70	42	20	14	7	100	65	25	140UE-J7S3-D25	140UE-J7S4-D25

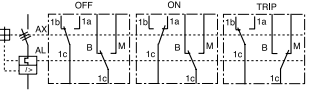
**Internal Control Modules — Field Installed**

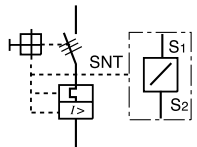
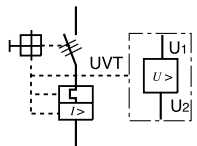
	Description	Mounting Location	Diagram	Cat. No.
	<b>Auxiliary Contact (AX)</b> Electrically indicates "ON/OFF" status of breakers	(1) 1a-1b		140U-H-EA1
		(2) 1a-1b		Left AND Right Side
	<b>Alarm Contact (AL)</b> Electrically indicates when the breaker is in the "TRIPPED" state	(1) 1M (make)-1B (break)		140U-J-ER1
				Right Side Only
	<b>Auxiliary/Alarm Contact (AX/AL) Combination</b> Combination of auxiliary contact and alarm contact	(1) 1a-1b (1) 1M (make)-1B (break)		140U-J-EA1R1
	<b>Shunt Trip (SNT)</b> Provides remote tripping of the circuit breaker Undervoltage trip not available when shunt trip is used	24...60V, 50/60/DC		140U-H-SNJ
		110...240V, 50/60/DC		140U-H-SND
		380...600V, 50/60 Hz		140U-H-SNB
	<b>Undervoltage Release (UVT)</b> Automatically trips breaker when voltage falls between preset value, 35...70% Shunt trip is not available when undervoltage release is used	24V, 50/60/DC		140U-H-UJ
		110...127V, 50/60 Hz		140U-H-UD
208...240V, 50/60 Hz		140U-H-UA		
	380...500V, 50/60 Hz	140U-H-UB		
	525...600V, 50/60 Hz	140U-H-UC		

**Internal Control Modules — Factory Installed**

Left side only

- (1) Shunt Trip (SNT)  
or
- (1) Undervoltage Release (UVT)

Mounting Location

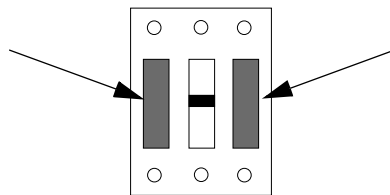

Right side only

- (1) Auxiliary contact (AX)  
or
- (2) Auxiliary contacts (AX)  
or
- (1) Alarm contact (AL)  
or
- (1) Alarm contact (AL) + Auxiliary contact (AX)

Auxiliary and Alarm Contacts	Suffix
(1) AX	- A
(2) AX	- B
(1) AL	- D
(1) AX + (1) AL	- F

Shunt Trip Combinations	Suffix
(1) SNT only	- P⊗
(1) AX + (1) SNT	- Q⊗
(2) AX + (1) SNT	- R⊗
(1) AX + (1) AL + (1) SNT	- T⊗
(1) AL + (1) SNT	- V⊗

⊗Standard Voltage Suffix Codes\*

Voltage [V]	24...60	110...240	380...600
AC, 50/60 Hz	J	D	B
DC	J	D	—

Undervoltage Release Combinations	Suffix
(1) UVT only	- G⊗
(1) AX + (1) UVT	- H⊗
(2) AX + (1) UVT	- J⊗
(1) AX + (1) AL + (1) UVT	- L⊗
(1) AL + (1) UVT	- N⊗

⊗Standard Voltage Suffix Codes\*

Voltage [V]	24	110...127	208...240	380...500	525...600
AC, 50/60 Hz	J	D	A	B	C
DC	J	—	—	—	—

\* For additional voltages, consult your local Allen-Bradley distributor.







External Accessories

	Description		For Use With	Cat. No.	
	<b>Terminal Shields</b> IP20 Ingress Protection Rating	Qty: 1	3-Pole MCCBs	140U-J-TS	
			4-Pole MCCBs	140U-J-TS4	
	<b>Flex-Cable Operating Mechanism</b> Non-Metallic IP 66/UL Type 1/3/12/4/4X Flange-Mount Operating Handle	Qty: 1	3- or 4-Pole MCCBs	3 ft. (0.9 m) Cable	140U-J-FCX03
				4 ft. (1.2 m) Cable	140U-J-FCX04
				6 ft. (1.9 m) Cable	140U-J-FCX06
				10 ft. (3.0 m) Cable	140U-J-FCX10
	<b>Flex-Cable Operating Mechanism</b> Stainless Steel IP66/ UL Type 1/3/12/4/4X Flange-Mount Operating Handle	Qty: 1	3- or 4-Pole MCCBs	3 ft. (0.9 m) Cable	140U-J-FCS03
				4 ft. (1.2 m) Cable	140U-J-FCS04
				6 ft. (1.9 m) Cable	140U-J-FCS06
				10 ft. (3.0 m) Cable	140U-J-FCS10
	<b>Rotary, Variable-Depth Operating Mechanism</b> IP66/ UL Type 1/3/12/4/4X Rotary Handle 12 in. (30.5 cm) operating rod	Black Handle	3- or 4-Pole MCCBs	140U-J-RVM12B	
	<b>Rotary, Variable-Depth Operating Mechanism</b> IP66/ UL Type 1/3/12/4/4X Rotary Handle 21 in. (53.3 cm) operating rod			140U-J-RVM21B	
	<b>Rotary, Variable-Depth Operating Mechanism</b> IP66/ UL Type 1/3/12/4/4X Rotary Handle 12 in. (30.5 cm) operating rod	Red/Yellow Handle		140U-J-RVM12R	
	<b>Rotary, Variable-Depth Operating Mechanism</b> IP66/ UL Type 1/3/12/4/4X Rotary Handle 21 in. (53.3 cm) operating rod			140U-J-RVM21R	
	<b>Rotary, Direct Couple Operating Mechanism</b> Breaker Mounted	Black Handle	3- or 4-Pole MCCBs	140U-J-RCB	
		Red/Yellow Handle		140U-J-RCR	
	<b>Phase Barriers</b> Provides additional phase clearance when special connections that extend past the circuit breaker housing are required	Qty: 2	3-Pole MCCBs	140U-J-PB	
			4-Pole MCCBs	140U-J-PB4	
	<b>Padlock Kit</b> Padlocking Hasp Lock-OFF only	Qty: 1	3- or 4-Pole MCCBs	140U-J-PL	
	<b>Terminal Lugs</b> Stainless Steel Box Lugs Copper Wire Only (1) 4...350 MCM (1) 25...185 mm <sup>2</sup>	Qty: 1	3- or 4-Pole MCCBs	140U-J-TLS1	
	<b>Terminal Lugs</b> Aluminum Lugs Aluminum or Copper Wire (1) 4...350 MCM (1) 25...185 mm <sup>2</sup>	Qty: 1	3- or 4-Pole MCCBs	140U-J-TLA1	
	<b>End Cap Kit</b> Provides 3-phase connections for terminal or bolt-on connections Metric Hardware	Qty: 1	3-Pole MCCBs	140U-J-ECM	
			4-Pole MCCBs	140U-J-ECM4	

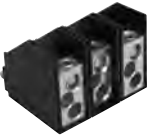
# Molded Case Circuit Breakers

Accessories — 250 A, J Frame, Continued

## External Accessories, Continued

	Description		For Use With	Cat. No.
	<b>Multi-Tap Terminal Lug Kit</b> — with IP20 terminal cover (3) #14...#2 AWG (3) 2.5...25 mm <sup>2</sup>	Qty: 3	3-Pole MCCBs	140U-J-MTL3A
	<b>Multi-Tap Terminal Lugs</b> — with IP20 terminal cover (6) #14...#6 AWG (6) 2.5...10 mm <sup>2</sup>			140U-J-MTL6A
	<b>Multi-Tap Terminal Lugs</b> — with IP20 terminal cover (3) #14...#2 AWG (3) 2.5...25 mm <sup>2</sup>	Qty: 4	4-Pole MCCBs	140U-J-MTL3A4
	<b>Multi-Tap Terminal Lugs</b> — with IP20 terminal cover (6) #14...#6 AWG (6) 2.5...10 mm <sup>2</sup>			140U-J-MTL6A4
	<b>Plug-in Base Adapters</b> Plug-in provides power terminations and adapter	Qty: 1	3-Pole MCCBs	140U-J-PAD3
	<b>Plug-in Base Auxiliary Contacts</b> Provides auxiliary contact functions to detect breaker insulation status		4-Pole MCCBs	140U-J-PAD4
	<b>Mounting Hardware</b> (4) M4 - 0.7 x 90 mm	Qty: 1	3- or 4-Pole MCCBs	140U-J-MHM
	<b>Slide Bar Interlock</b>	Qty: 1	3- or 4-Pole MCCBs	140U-J-SBLK
	<b>Motor Operator</b> Remotely opens, closes, and resets the circuit breaker	Qty: 1	3- or 4-Pole MCCBs, 110...240V AC/DC	140U-J-EOPD
			3- or 4-Pole MCCBs, 24V DC	140U-J-EOPZ
	<b>160 A Earth Leakage Module</b> 0.3...10 A, adjustable	Qty: 1	3-Pole MCCBs	140U-J-ELP1603
			4-Pole MCCBs	140U-J-ELP1604
	<b>250 A Earth Leakage Module</b> 0.3...10 A, adjustable	Qty: 1	3-Pole MCCBs	140U-J-ELP2503
	4-Pole MCCBs		140U-J-ELP2504	

**630 A, L-Frame**

- IEC 60947-2
- CE
- KEMA-KEUR

**Note:** Terminal box lugs and mounting hardware provided as standard.

Circuit breakers can be assembled from a circuit breaker frame and a trip unit, or purchased as assembled units.



Example:

Cat. No. **140UE-L3X3** (frame) + Cat. No. **140UE-LTF3-D25** (trip unit) = Cat. No. **140UE-L3F3-D25** (equivalent assembled circuit breaker)

**Breaker Frames**

Rated Current $I_n$ [A]	Breaking Capacity (50 Hz) $I_{cu} / I_{cs}$ [kA]								NEMA Interrupt Rating (60 Hz) [kA]			Cat. No.	
	220...240V		380...415V		500V		690V		240V	480V	600V	3-Pole	4-Pole
630 A	65	65	35	35	18	18	12	9	65	35	18	140UE-L3X3	140UE-L3X4
	85	85	50	50	25	25	20	10	85	50	25	140UE-L5X3	140UE-L5X4
	100	100	70	70	35	35	25	13	100	65	35	140UE-L7X3	140UE-L7X4

**Trip Units, Thermal-Magnetic**

Rated Operational Current $I_n$	Adjustment Range [A]		Protection Type	Cat. No.	
	Thermal Trip $I_r = (0.8...1.0) I_n$ (Adjustable)	Magnetic Trip $I_m = 5...10 \times I_n$		3-Pole	4-Pole *
250	200...250	1250...2500	AA	140UE-LTF3-D25	140UE-LTF4-D25
320	256...320	1600...3200	AA	140UE-LTF3-D32	140UE-LTF4-D32
400	320...400	2000...4000	AA	140UE-LTF3-D40	140UE-LTF4-D40
500	400...500	2500...5000	AA	140UE-LTF3-D50	140UE-LTF4-D50
630	504...630	3150...6300	AA	140UE-LTF3-D63	140UE-LTF4-D63

\* 4th pole neutral — 0/100% protected

**Trip Units, Electronic\***

Rated Operational Current $I_n$	Adjustment Range [A]		Protection Type	Ground Fault Functions		Cat. No.	
	Thermal Trip * $I_r = 0.4...1.0 \times I_n$	Magnetic Trip $I_m = 2...10 \times I_n$		$I_G=0.2...1.0I_n$	$T_G=ms$	3-Pole	4-Pole
630	250...630	1260...6300	250...630 A LS Electronic Trip Unit	—	—	140UE-LTL3-D63	140UE-LTL4-D63
630	250...630	1260...6300	250...630 A LSI Electronic Trip Unit	—	—	140UE-LTH3-D63	140UE-LTH4-D63
630	250...630	1260...6300	250...630 A LSG Electronic Trip Unit	126...630	Inst., 120, 300	140UE-LTG3-D63	140UE-LTG4-D63
630	250...630	1260...6300	250...630 A LSIG Electronic Trip Unit	126...630	Inst., 120, 300	140UE-LTI3-D63	140UE-LTI4-D63

\* Adjustable long-time delay: 2...24 s at 6 time  $I_r$

\* Thermal trip settings: 250, 300, 315, 400, 500, 600, 630 A

# Molded Case Circuit Breakers

Product Selection — 630 A, L Frame, Continued

## Assembled Circuit Breakers, Thermal-Magnetic Trip Units

Rated Operational Current $I_n$	Protection Type $I_n$	Breaking Capacity 380...415V (50 Hz)					
		3 Poles			4 Poles		
		35 kA Cat. No.	50 kA Cat. No.	70 kA Cat. No.	35 kA Cat. No.	50 kA Cat. No.	70 kA Cat. No.
250	AA	140UE-L3F3-D25	140UE-L5F3-D25	140UE-L7F3-D25	140UE-L3F4-D25	140UE-L5F4-D25	140UE-L7F4-D25
320	AA	140UE-L3F3-D32	140UE-L5F3-D32	140UE-L7F3-D32	140UE-L3F4-D32	140UE-L5F4-D32	140UE-L7F4-D32
400	AA	140UE-L3F3-D40	140UE-L5F3-D40	140UE-L7F3-D40	140UE-L3F4-D40	140UE-L5F4-D40	140UE-L7F4-D40
500	AA	140UE-L3F3-D50	140UE-L5F3-D50	140UE-L7F3-D50	140UE-L3F4-D50	140UE-L5F4-D50	140UE-L7F4-D50
630	AA	140UE-L3F3-D63	140UE-L5F3-D63	140UE-L7F3-D63	140UE-L3F4-D63	140UE-L5F4-D63	140UE-L7F4-D63

## Assembled Circuit Breakers, Electronic Trip Units

Rated Operational Current $I_n$	Protection Type	Breaking Capacity 380...415V (50 Hz)					
		3 Poles			4 Poles		
		35 kA Cat. No.	50 kA Cat. No.	70 kA Cat. No.	35 kA Cat. No.	50 kA Cat. No.	70 kA Cat. No.
630	250...630 A LS Electronic Trip Unit	140UE-L3L3-D63	140UE-L5L3-D63	140UE-L7L3-D63	140UE-L3L4-D63	140UE-L5L4-D63	140UE-L7L4-D63
630	250...630 A LSI Electronic Trip Unit	140UE-L3H3-D63	140UE-L5H3-D63	140UE-L7H3-D63	140UE-L3H4-D63	140UE-L5H4-D63	140UE-L7H4-D63
630	250...630 A LSG Electronic Trip Unit	140UE-L3G3-D63	140UE-L5G3-D63	140UE-L7G3-D63	140UE-L3G4-D63	140UE-L5G4-D63	140UE-L7G4-D63
630	250...630 A LSIg Electronic Trip Unit	140UE-L3I3-D63	140UE-L5I3-D63	140UE-L7I3-D63	140UE-L3I4-D63	140UE-L5I4-D63	140UE-L7I4-D63







## Isolation Disconnecter — IEC 60947-3

Rated Current $I_n$ [A]	Thermal Trip $I_r = I_n$ [A]	Magnetic Trip [A] $I_m = 10 \times I_n$	Breaking Capacity (50 Hz) $I_{cu} / I_{cs}$ [kA]				Interrupting Rating (60 Hz) [kA]			Cat. No.					
			220...240V	380...415V	500V	690V	240V	480V	600V	3-Pole	4-Pole				
630	—	6300	100	100	70	70	40	40	25	13	100	65	32	140UE-L7S3-D63	140UE-L7S4-D63

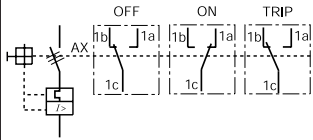
## Earth Leakage Protector

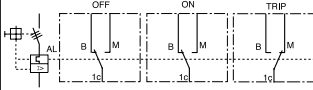
Earth Leakage Adjustment Range [A]	Max. Current [A]	Cat. No.	
		3-Pole	4-Pole
0.3...10	400	140U-L-ELP4003	140U-L-ELP4004
	630	140U-L-ELP6303	140U-L-ELP6304

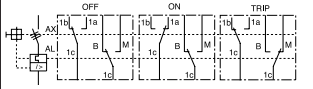
**Internal Control Modules — Field Installed**

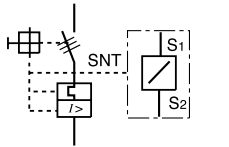
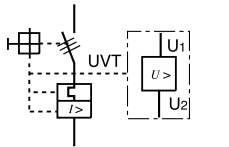
	Description	Mounting location	Diagram	Cat. No.
	<b>Auxiliary Contact (AX)</b> Electrically indicates "ON/OFF" status of breakers	(1) 1a-1b		140U-H-EA1
		(2) 1a-1b	—	140U-H-EA2
	<b>Alarm Contact (AL)</b> Electrically indicates when the breaker is in the "TRIPPED" state	(1) 1M (make)-1B (break)		140U-J-ER1
			<i>Right Side Only</i>	
	<b>Auxiliary/Alarm Contact (AX/AL) Combination</b> Combination of auxiliary contact and alarm contact	(1) 1a-1b (1) 1M (make)-1B (break)		140U-J-EA1R1
			<i>Right Side Only</i>	
	<b>Shunt Trip (SNT)</b> Provides remote tripping of the circuit breaker Undervoltage trip not available when shunt trip is used	24...60V, 50/60/DC		140U-H-SNJ
		110...240V, 50/60/DC		140U-H-SND
		380...440V AC, 220...250V DC		140U-H-SNN
	<b>Undervoltage Release (UVT)</b> Automatically trips breaker when voltage falls between preset value, 35...70% Shunt trip is not available when undervoltage release is used	380...600V, 50/60 Hz	<i>Left Side Only</i>	140U-H-SNB
		24V, 50/60/DC		140U-H-UJ
		110...127V, 50/60 Hz		140U-H-UD
208...240V, 50/60 Hz	140U-H-UA			
	380...500V, 50/60 Hz	—	140U-H-UB	

**Internal Control Modules — Factory Installed**

*Left side only*

(1) Shunt Trip (SNT)  
 or  
 (1) Undervoltage Release (UVT)

**Mounting Location**

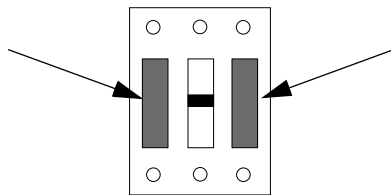

*Right side only*

(1) Auxiliary contact (AX)  
 or  
 (2) Auxiliary contacts (AX)  
 or  
 (1) Alarm contact (AL)  
 or  
 (1) Alarm contact (AL) + Auxiliary contact (AX)

Auxiliary and Alarm Contacts	Suffix
(1) AX	- A
(2) AX	- B
(1) AL	- D
(1) AX + (1) AL	- F

Shunt Trip Combinations	Suffix
(1) SNT only	- P⊗
(1) AX + (1) SNT	- Q⊗
(2) AX + (1) SNT	- R⊗
(1) AX + (1) AL + (1) SNT	- T⊗
(1) AL + (1) SNT	- V⊗

Undervoltage Release Combinations	Suffix
(1) UVT only	- G⊗
(1) AX + (1) UVT	- H⊗
(2) AX + (1) UVT	- J⊗
(1) AX + (1) AL + (1) UVT	- L⊗
(1) AL + (1) UVT	- N⊗

⊗Standard Voltage Suffix Codes\*

Voltage [V]	24...60	110...240	380...600
AC, 50/60 Hz	J	D	B
DC	J	D	—

⊗Standard Voltage Suffix Codes\*

Voltage [V]	24	110...127	208...240	380...500	525...600
AC, 50/60 Hz	J	D	A	B	C
DC	J	—	—	—	—

\* For additional voltages, consult your local Allen-Bradley distributor.



# Molded Case Circuit Breakers

Accessories — 630 A, L Frame, Continued

## External Accessories

	Description		Cat. No.
	<b>Terminal Shields</b> IP20 Ingress Protection Rating	Qty: 1	140U-L-TS
	Terminal Shield, 4-Pole	Qty: 1	140U-L-TS4
	Plug-in Adapter, 3-Pole	Qty: 1	140U-L-PAD3
	Plug-in Adapter, 4-Pole	Qty: 1	140U-L-PAD4
	Plug-in Adapter Aux Contact	Qty: 1	140U-L-PDK
	Motor Operator, 110..240V AC	Qty: 1	140U-L-EOPD
	Motor Operator, 24V DC	Qty: 1	140U-L-EOPZ
	Sliding Bar Interlock	Qty: 1	140U-L-SBLK
	<b>Flex-Cable Operating Mechanism</b> Includes handle, cable, operating, and bail mechanism Pre-assembled and adjusted UL Type 1/3/12/4/4X Flange-Mount Operating Handle Non-Metallic	4 ft. (1.2 m) Cable	140U-L-FCX04
		6 ft. (1.9 m) Cable	140U-L-FCX06
		10 ft. (3.0 m) Cable	140U-L-FCX10
	<b>Flex-Cable Operating Mechanism</b> Includes handle, cable, operating, and bail mechanism Pre-assembled and adjusted UL Type 4/4X Flange-Mount Operating Handle Stainless Steel	4 ft. (1.2 m) Cable	140U-L-FCS04
		6 ft. (1.9 m) Cable	140U-L-FCS06
		10 ft. (3.0 m) Cable	140U-L-FCS10
	<b>Rotary, Variable-Depth Operating Mechanism</b> UL Type 3/12/4/4X, IP 66 Rotary Handle 12 in. (30.48 cm) operating rod	Black Handle	140U-L-RVM12B
		Red/Yellow Handle	140U-L-RVM12R
	<b>Rotary, Variable-Depth Operating Mechanism</b> UL Type 3/12/4/4X, IP 66 Rotary Handle 12 in. (30.48 cm) operating rod	Black Handle	140U-L-RVM21B
		Red/Yellow Handle	140U-L-RVM21R
	<b>End Cap Kit</b> Provides 3-phase connections for terminal or bolt-on connections Metric Hardware Provided	Qty: 1	140U-L-ECM
	End Cap Kit, 4-Pole - Metric Hardware (1)	Qty: 1	140U-L-ECM4
	<b>Mounting Hardware</b> (4) M5 - 0.8 x 100 mm	Qty: 1	140U-L-MHM

Optional Terminal Lug Kits

	Description	Terminal Body Material	Wire Type	Wire Size, AWG	Wire Size, Metric	Pkg. Quantity	Cat. No.
	<b>Terminal Lugs</b>	Aluminum	Cu/Al	(1) 500...750 MCM	(1) 240...380 mm <sup>2</sup>	3 (includes shield)	140U-L-TL6A1
						4 (includes shield)	140U-L-TL6A14
Copper		Cu only	(1) 500...750 MCM	(1) 240...380 mm <sup>2</sup>	3 (includes shield)	140U-L-TL6C1	
					4 (includes shield)	140U-L-TL6C14	
		Aluminum	Cu/Al	(2) 2...500 MCM	(2) 35...240 mm <sup>2</sup>	3 (includes shield)	140U-L-TL6A2
						4 (includes shield)	140U-L-TL6A24
Copper		Cu only	(2) 2...500 MCM	(2) 35...240 mm <sup>2</sup>	3 (includes shield)	140U-L-TL6C2	
					4 (includes shield)	140U-L-TL6C24	
		Aluminum	Cu/Al	(1) 2...500 MCM	(1) 35...240 mm <sup>2</sup>	1	140U-L-TL4A1
		Copper	Cu only				140U-L-TL4C1

**800 A, M-Frame**

- IEC 60947-2
- CE
- KEMA-KEUR

**Note:** Terminal box lugs and mounting hardware must be ordered separately. See page 27



**Breaker Frames**

Rated Current $I_n$	Breaking Capacity (50 Hz) $I_{cu} / I_{cs}$ [kA]								Interrupting Rating (60 Hz) [kA]			3-Pole
	220...240V		380...415V		500V		690V		240V	480V	600V	Cat. No.
800	65	65	50	50	25	25	20	10	65	50	25	140UE-M5X3
	100	100	70	50	35	13	25	13	100	65	35	140UE-M7X3

**Trip Units and Rating Plugs**

**Trip Units, Thermal-Magnetic**

Rated Current $I_n$	Adjustment Range [A]		3-Pole
	Thermal Trip $I_t = I_n$	Magnetic Trip $I_m = 5...10 \times I_n$	Cat. No.
300	300	1500...3000	140UE-MTD3-D30
350	350	1750...3500	140UE-MTD3-D35
400	400	2000...4000	140UE-MTD3-D40
450	450	2250...4500	140UE-MTD3-D45
500	500	2500...5000	140UE-MTD3-D50
600	600	3000...5000	140UE-MTD3-D60
700	700	3500...7000	140UE-MTD3-D70
800	800	4000...8000	140UE-MTD3-D80

**Trip Units, Electronic**

Rated Operational Current $I_n$	Adjustment Range [A]		Protection Type	Ground Fault Functions		Cat. No.
	Thermal Trip $I_t = 0.5...1.0 \times I_n$	Magnetic Trip $I_m = 2...8 \times I_n$		$I_G=0.2...1.0/I_n$	$T_G=ms$	
800A	400...800*	800...6400	400...800 A LS Electronic Trip Unit	—	—	140UE-MTL3-D80
	400...800*		400...800 A LSI Electronic Trip Unit	—	—	140UE-MTH3-D80
	400...800*		400...800 A LSG Electronic Trip Unit	126...630	Inst.,120, 300	140UE-MTG3-D80
	400...800*		400...800 A LSIG Electronic Trip Unit	126...630	Inst.,120, 300	140UE-MTI3-D80

\* Complete circuit breaker with electronic trip unit requires purchase of a rating plug.

**Rating Plugs**

Rating Plugs	
Description	Cat. No.
400/500/630/800 A Rating Plug	140UE-MAP3-D80

**Assembled Circuit Breakers, Thermal-Magnetic Trip Units**







Rated Operational Current $I_n$	Protection Type	3-Pole	
		50 kA	70 kA
		Cat. No.	Cat. No.
300	FA	140UE-M5D3-D30	140UE-M7D3-D30
350	FA	140UE-M5D3-D35	140UE-M7D3-D35
400	FA	140UE-M5D3-D40	140UE-M7D3-D40
450	FA	140UE-M5D3-D45	140UE-M7D3-D45
500	FA	140UE-M5D3-D50	140UE-M7D3-D50
600	FA	140UE-M5D3-D60	140UE-M7D3-D60
700	FA	140UE-M5D3-D70	140UE-M7D3-D70
800	FA	140UE-M5D3-D80	140UE-M7D3-D80

**Assembled Circuit Breakers, Electronic Trip Units**

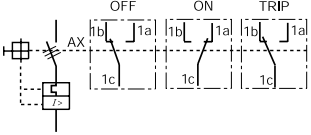
Protection Type	3-Pole	
	50 kA	70 kA
	Cat. No.	Cat. No.
400...800 A LS Electronic Trip Unit *	140UE-M5L3-D80	140UE-M7L3-D80
400...800 A LSI Electronic Trip Unit *	140UE-M5H3-D80	140UE-M7H3-D80
400...800 A LSG Electronic Trip Unit *	140UE-M5G3-D80	140UE-M7G3-D80
400...800 A LSIG Electronic Trip Unit *	140UE-M5I3-D80	140UE-M7I3-D80

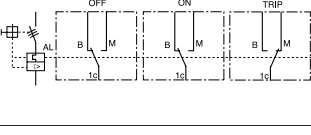
\* Complete circuit breaker with electronic trip unit requires purchase of a rating plug.

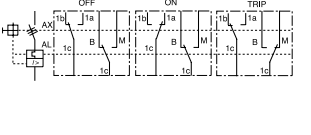
**Internal Control Modules — Field Installed**

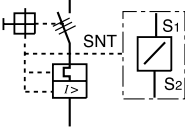
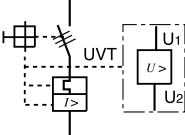
	Description	Mounting Location	Diagram	Cat. No.
	<b>Auxiliary Contact (AX)</b> Electrically indicates "ON/OFF" status of breakers	(1) 1a-1b		140U-M-EA1
		(2) 1a-1b		Left AND Right side
	<b>Alarm Contact (AL)</b> Electrically indicates when the breaker is in the "TRIPPED" state	(1) 1M (make)-1B (break)		140U-M-ER1
				Right side ONLY
	<b>Auxiliary/Alarm Contact (AX/AL) Combination</b> Combination of auxiliary contact and alarm contact	(1) 1a-1b (1) 1M (make)-1B (break)		140U-M-EA1R1
				Right side ONLY
	<b>Shunt Trip (SNT)</b> Provides remote tripping of the circuit breaker Undervoltage trip not available when shunt trip is used	12...24V, 50/60/DC		140U-M-SNJ
		110...240V AC, 110...125V DC		140U-M-SND
		380...440V AC, 220...250V DC		140U-M-SNN
		480...600V, 50/60 Hz		140U-M-SNB
	<b>Undervoltage Release (UVT)</b> Automatically trips breaker when voltage falls between preset value, 35...70% Shunt trip is not available when undervoltage release is used	24V, 50/60 Hz		140U-M-UJ
		110...127V, 50/60 Hz		140U-M-UD
		208...240V, 50/60 Hz		140U-M-UA
		380...500V, 50/60 Hz		140U-M-UB
		Left side ONLY		
		Left side ONLY		

**Internal Control Modules — Factory Installed**

Left side only

- (1) Shunt Trip (SNT)  
or
- (1) Undervoltage Release (UVT)

Mounting Location

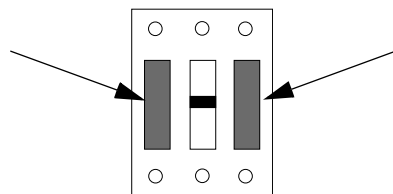

Right side only

- (1) Auxiliary contact (AX)  
or
- (2) Auxiliary contacts (AX)  
or
- (1) Alarm contact (AL)  
or
- (1) Alarm contact (AL) + Auxiliary contact (AX)

Auxiliary and Alarm Contacts	Suffix
(1) AX	- A
(2) AX	- B
(1) AL	- D
(1) AX + (1) AL	- F

Shunt Trip Combinations		Suffix
(1) SNT only		- P⊗
(1) AX + (1) SNT		- Q⊗
(2) AX + (1) SNT		- R⊗
(1) AX + (1) AL + (1) SNT		- T⊗
(1) AL + (1) SNT		- V⊗

Undervoltage Release Combinations		Suffix
(1) UVT only		- G⊗
(1) AX + (1) UVT		- H⊗
(2) AX + (1) UVT		- J⊗
(1) AX + (1) AL + (1) UVT		- L⊗
(1) AL + (1) UVT		- N⊗

⊗Standard Voltage Suffix Codes\*











Voltage [V]	12...24	110...240	380...440	480...600
AC, 50/60 Hz	J	D	N	B
Voltage [V]	12...24	110...125	220...250	—
DC	J	D	N	—

⊗Standard Voltage Suffix Codes\*

Voltage [V]	24	110...127	208...240	380...480
AC, 50/60 Hz	J	D	A	B
Voltage [V]	—	—	—	—
DC	—	—	—	—

\* For additional voltages, consult your local Allen-Bradley distributor.

External Accessories

	Description	Cat. No.
	<b>Flex-Cable Operating Mechanism</b> Includes handle, cable, operating, and bail mechanism Pre-assembled and adjusted UL Type 1/3/12/4/4X Flange-Mount Operating Handle Non-Metallic	4 ft. (1.2 m) Cable 140U-M-FCX04
		6 ft. (1.9 m) Cable 140U-M-FCX06
		10 ft. (3.0 m) Cable 140U-M-FCX10
	<b>Flex-Cable Operating Mechanism</b> Includes handle, cable, operating, and bail mechanism Pre-assembled and adjusted UL Type 4/4X Flange-Mount Operating Handle Stainless Steel	4 ft. (1.2 m) Cable 140U-M-FCS04
		6 ft. (1.9 m) Cable 140U-M-FCS06
		10 ft. (3.0 m) Cable 140U-M-FCS10
	<b>Rotary, Variable-Depth Operating Mechanism</b> Type 1/3, 4, 4X, 12 Rotary Handle 12 in. (30.48 cm) operating rod	Black Handle 140U-M-RVM12B
		Red/Yellow Handle 140U-M-RVM12R
	<b>Rotary, Variable-Depth Operating Mechanism</b> Type 1/3, 4, 4X, 12 Rotary Handle 21 in. (53.34 cm) operating rod	Black Handle 140U-M-RVM21B
	<b>Rotary, Variable-Depth Operating Mechanism</b> Type 1/3, 4, 4X, 12 Rotary Handle 21 in. (53.34 cm) operating rod	Red/Yellow Handle 140U-M-RVM21R
	<b>Terminal Lugs</b> Copper Lug Copper Wire Only (3) 3/0...300 MCM (3) 95...135 mm <sup>2</sup>	Qty: 1 140U-M-TLC3
	<b>Terminal Lugs</b> Aluminum Lug Aluminum or Copper Wire (3) 3/0...400 MCM (3) 95...185 mm <sup>2</sup>	Qty: 1 140U-M-TLA3
	<b>Terminal Lugs</b> Aluminum Lug Aluminum or Copper Wire (2) 1...500 MCM (2) 50...240 mm <sup>2</sup>	Qty: 1 140U-M-TLA2
	<b>Terminal Lugs</b> Aluminum Lug Aluminum or Copper Wire (2) 500...750 MCM (2) 240...400 mm <sup>2</sup>	Qty: 1 140U-M-TLA2A
	<b>Terminal Lugs</b> Copper Lug Copper Wire only (2) 2/0...500 MCM (2) 70...240 mm <sup>2</sup>	Qty: 1 140U-M-TLC2
	<b>Phase Barriers</b> Provides additional phase clearance when special connections that extend past the circuit breaker housing are required	Qty: 2 140U-M-PB
	<b>Padlock Kit</b> Padlocking Hasp Lock-OFF only	Qty: 1 140U-M-PL
	<b>Operating Handle Extension</b> Provides handle extension for ease of operation	Qty: 1 140U-M-OHE
	<b>Mounting Hardware</b> (4) M8 - 1 x 35 mm	Qty: 1 140U-M-MHM

**1250 A, N-Frame**

- IEC 60947-2
- CE
- KEMA-KEUR

**Note:** Terminal box lugs and mounting hardware must be ordered separately. See page 28



**Assembled Circuit Breakers, Electronic Trip Units**







Rated Current $I_n$ [A]	Adjustment Range $I_r$ [A]		Protection Type	Breaking Capacity (50 Hz)								Interrupting Rating (60 Hz) [kA]			3-Pole	4-Pole
	Thermal Trip $I_r = 0.5...1.0 \times I_n$	Magnetic Trip $I_m = 2...8 \times I_n$		$I_{cu} // I_{cs}$ [kA]											Cat. No.	Cat. No.
				220...240V	380...415V		500V		690V		240V	480V	600V			
<b>70 kA Assembled Electronic Circuit Breakers</b>																
1250	600...1250*	2400..10000	LS	100	100	70	50	50	25	25	13	100	65	35	<a href="#">140UE-N5L3-E12</a>	<a href="#">140UE-N5L4-E12</a>
			LSI	100	100	70	50	50	25	25	13	100	65	35	<a href="#">140UE-N5H3-E12</a>	<a href="#">140UE-N5H4-E12</a>
			LSG	100	100	70	50	50	25	25	13	100	65	35	<a href="#">140UE-N5G3-E12</a>	<a href="#">140UE-N5G4-E12</a>
			LSIG	100	100	70	50	50	25	25	13	100	65	35	<a href="#">140UE-N5I3-E12</a>	<a href="#">140UE-N5I4-E12</a>
<b>100 kA Assembled Electronic Circuit Breakers</b>																
1250	600...1250*	2400..10000	LS	200	100	100	50	65	33	35	18	200	100	50	<a href="#">140UE-N0L3-E12</a>	<a href="#">140UE-N0L4-E12</a>
			LSI	200	100	100	50	65	33	35	18	200	100	50	<a href="#">140UE-N0H3-E12</a>	<a href="#">140UE-N0H4-E12</a>
			LSG	200	100	100	50	65	33	35	18	200	100	50	<a href="#">140UE-N0G3-E12</a>	<a href="#">140UE-N0G4-E12</a>
			LSIG	200	100	100	50	65	33	35	18	200	100	50	<a href="#">140UE-N0I3-E12</a>	<a href="#">140UE-N0I4-E12</a>

\* Breakers include adjustable rating plug 600/800/1000/1200 A

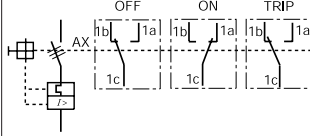
**Isolation Disconnecter — IEC 60974-3**

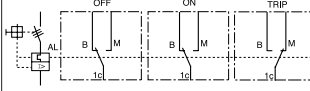
Rated Current $I_n$	Magnetic Trip $10 \times I_n$	Breaking Capacity (50 Hz) $I_{cu} // I_{cs}$ [kA]								Interrupting Rating (60 Hz) [kA]			Cat. No.	Cat. No.
		220...240V	380...415V		500V		690V		240V	480V	600V			
1250	12500	100	100	70	50	50	25	25	13	100	65	35	<a href="#">140UE-N7S3-E12</a>	<a href="#">140UE-N7S4-E12</a>

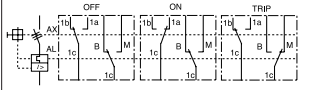
**Internal Control Modules — Field Installed**

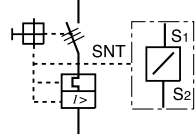
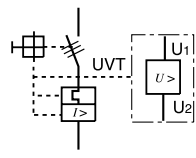
	Description	Mounting Location	Diagram	Cat. No.
	<b>Auxiliary Contact (AX)</b> Electrically indicates "ON/OFF" status of breakers	(1) 1a-1b		140U-N-EA1
		(2) 1a-1b		Left AND Right side
	<b>Alarm Contact (AL)</b> Electrically indicates when the breaker is in the "TRIPPED" state	(1) 1M (make)-1B (break)		140U-N-ER1
				Right side ONLY
	<b>Auxiliary/Alarm Contact (AX/AL) Combination</b> Combination of auxiliary contact and alarm contact	(1) 1a-1b (1) 1M (make)-1B (break)		140U-N-EA1R1
	<b>Shunt Trip (SNT)</b> Provides remote tripping of the circuit breaker Undervoltage trip not available when shunt trip is used	12...24V, 50/60/DC		140U-N-SNJ
		110...240V AC, 110...125V DC		140U-N-SND
		380...440V AC, 220...250V DC		140U-N-SNN
		480...600V, 50/60 Hz		140U-N-SNB
	<b>Undervoltage Release (UVT)</b> Automatically trips breaker when voltage falls between preset value, 35...70% Shunt trip is not available when undervoltage release is used	24V, 50/60 Hz		140U-N-UJ
		110...127V, 50/60 Hz		140U-N-UD
	208...240V, 50/60 Hz		140U-N-UA	
	380...500V, 50/60 Hz	Left side ONLY	140U-N-UB	

**Internal Control Modules — Factory Installed**

Left side only

- (1) Shunt Trip (SNT)
- or
- (1) Undervoltage Release (UVT)

Mounting Location

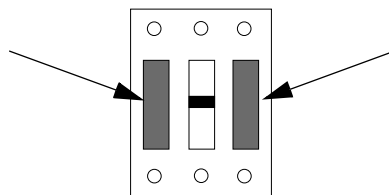

Right side only

- (1) Auxiliary contact (AX)
- or
- (2) Auxiliary contacts (AX)
- or
- (1) Alarm contact (AL)
- or
- (1) Alarm contact (AL) + Auxiliary contact (AX)

Auxiliary and Alarm Contacts	Suffix
(1) AX	- A
(2) AX	- B
(1) AL	- D
(1) AX + (1) AL	- F

Shunt Trip Combinations					Suffix
(1) SNT only					- P⊗
(1) AX + (1) SNT					- Q⊗
(2) AX + (1) SNT					- R⊗
(1) AX + (1) AL + (1) SNT					- T⊗
(1) AL + (1) SNT					- V⊗
⊗Standard Voltage Suffix Codes*					
Voltage [V]	12...24	110...240	380...440	480...600	
AC, 50/60 Hz	J	D	N	B	
Voltage [V]	12...24	110...125	220...250	—	
DC	J	D	N	—	

Undervoltage Release Combinations					Suffix
(1) UVT only					- G⊗
(1) AX + (1) UVT					- H⊗
(2) AX + (1) UVT					- J⊗
(1) AX + (1) AL + (1) UVT					- L⊗
(1) AL + (1) UVT					- N⊗
⊗Standard Voltage Suffix Codes*					
Voltage [V]	24	110...127	208...240	380...480	
AC, 50/60 Hz	J	D	A	B	
Voltage [V]	—	—	—	—	
DC	—	—	—	—	

\* For additional voltages, consult your local Allen-Bradley distributor.

## Molded Case Circuit Breakers

Accessories — 1250 A, N Frame, Continued

### External Accessories

	Description		Cat. No.
	<b>Flex-Cable Operating Mechanism</b> NEMA Type 1/3/12/4/4X Flange-Mount Handle	4 ft. (1.2 m) Cable	140U-N-FCX04
		6 ft. (1.9 m) Cable	140U-N-FCX06
		10 ft. (3.0 m) Cable	140U-N-FCX10
	<b>Rotary, Variable-Depth Operating Mechanism</b> Type 1/12 Rotary Handle 12 in. (30.48 cm) operating rod	Black Handle	140U-N-RM12B
	<b>Phase Barriers</b> Provides additional phase clearance when special connections that extend past the circuit breaker housing are required	Qty: 2	140U-N-PB
	<b>Padlock Kit</b> Padlocking Hasp Lock-OFF only	Qty: 1	140U-N-PL
	Motor Operator, 110..120V AC	Qty: 1	140U-N-EOPD
	Motor Operator, 230..240V AC	Qty: 1	140U-N-EOPA
	Motor Operator, 24V DC	Qty: 1	140U-N-EOPZ
	Slide Bar Interlock — for interlocking adjacent circuit breakers	Qty: 1	140U-N-SBLK
	<b>Mounting Hardware</b> (4) M8 - 1 x 35 mm	Qty: 1	140U-M-MHM

### Terminal Lugs

	Product Description	Terminal Body Material	Wire Type	Wire Size, AWG	Wire Size, Metric	Pkg. Quantity	Cat. No.
	Terminal Lug	Copper	Cu	(4) 3/0...400 MCM	(4) 95...185 mm <sup>2</sup>	Qty: 1	140U-N-TLC4M
		Aluminum	Cu/Al	(4) 4/0...500 MCM	(4) 120...300 mm <sup>2</sup>	Qty: 1	140U-N-TLA4M

Dimensions are in millimeters (inches). Dimensions are not intended to be used for manufacturing purposes.

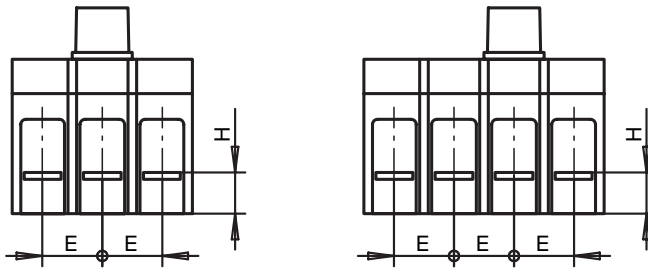
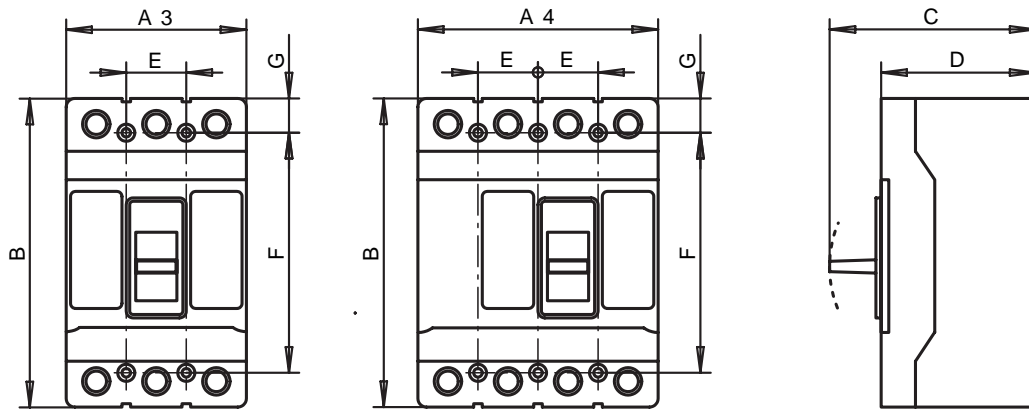

	A3	A4	B	C	D	E	F	G	H
H-Frame	77 (3)	102 (4)	140 (5-1/2)	88 (3-1/2)	75 (3)	25.4 (1)	96.8 (3-13/16)	24.6 (31/32)	22.4 (7/8)
J-Frame	105 (4-1/8)	140 (5-1/2)	178 (7)	113 (4-29/64)	88 (3-1/2)	35 (1-3/8)	139.7 (5-1/2)	19.8 (25/32)	20.6 (13/16)
L-Frame	140 (5-1/2)	184 (7-1/4)	258 (10-5/32)	138 (5-7/16)	110 (4-21/64)	43.7 (1-23/32)	214.4 (8-7/16)	21.3 (27/32)	24.7 (31/32)
M-Frame	210 (8-17/64)	—	407 (16-1/64)	139 (5-15/32)	104 (4-3/32)	69.9 (2-3/4)	374.7 (14-3/4)	16 (5/8)	26.2 (1-1/32)
N-Frame	210 (8-17/64)	280 (11-1/64)	407 (16-1/64)	183 (7-13/64)	140 (5-1/2)	69.9 (2-3/4)	374.7 (14-3/4)	16 (5/8)	29.5 (1-5/32)





[www.rockwellautomation.com](http://www.rockwellautomation.com)

---

**Power, Control and Information Solutions Headquarters**

Americas: Rockwell Automation, 1201 South Second Street, Milwaukee, WI 53204-2496 USA, Tel: (1) 414.382.2000, Fax: (1) 414.382.4444

Europe/Middle East/Africa: Rockwell Automation, Vorstlaan/Boulevard du Souverain 36, 1170 Brussels, Belgium, Tel: (32) 2 663 0600, Fax: (32) 2 663 0640

Asia Pacific: Rockwell Automation, Level 14, Core F, Cyberport 3, 100 Cyberport Road, Hong Kong, Tel: (852) 2887 4788, Fax: (852) 2508 1846