





Bulletin 1606
Power Supplies
 Product Overview

				
Bulletin	1606-XLS	1606-XLE	1606-XLP	1606-XL
Type	Single/Three Phase	Single Phase	Single/Two Phase	Single/Three Phase
Features	<ul style="list-style-type: none"> Ultra-small size Extra-low inrush current Active power factor correction Wide range AC/DC input; auto select input Superior reserve power (can support 150% rated power for five seconds) Superior efficiency and temperature rating DC OK and overload LED 	<ul style="list-style-type: none"> Low inrush current Ultra-small size Auto select input Superior overload design Superior efficiency and temperature rating Regional voltage input 	<ul style="list-style-type: none"> Low inrush current Wide range input with auto select Superior overload design (continuous current, no hiccup) NEC Class 2 "Limited Power" Superior efficiency and temperature rating 	<ul style="list-style-type: none"> Low inrush current PFC Choke Wide range input; auto select input Superior overload design (continuous current, no hiccup) NEC Class 2 "Limited Power" Selectable operating mode (single/parallel) Superior efficiency and temperature rating Output signals
Output Power	80...480 W	80...240 W	15...100 W	60...960 W
Input Voltage / Primary Voltage	85...276/323...552V AC 88...375/450...780V DC	90...132/180...264V AC	85...264V AC 85...375V DC	85...132/176...264/340...576V AC 160...375/450...820V DC
Efficiency	91.6...95%	90...92%	80...90%	87...93%
Output Voltage / Secondary Voltage	24V DC	24, 48V DC	5, 10...12, 12, 15, 24, 48V DC	24, 36, 48V DC
Rated Output Current	3.4...20 A	3.4...10 A	0.63...4.2 A	2.5...40 A
Operating Temperature Range (Tamb)	-25...+70 °C >60 °C with derating	-25...+70 °C >60 °C with derating	-10...+70 °C >60 °C with derating	-10...+70 °C >60 °C with derating
Non-Operating Temperature Range	-40...+85 °C			
Certifications	cULus, CE	UL, CE, CSA	cULus, CE, CSA	cULus, CE
Standards	EN 55011 (Class B), EN 55022 (Class B), EN 61000-6-2, EN 61000-3-2 (A14), EN 50081-1 UL 508 UL 1950	EN 55011 (Class B), EN 55022 (Class B), EN 61000-6-2, EN 61000-3-2 (A14), EN 50081-1 UL 508 UL 1950 CAN/CSA C22.2 No. 107-1	EN 50081-1, EN 61000-6-2, EN 61000-3-2 (A14) UL 508 UL 60950, CAN/CSA C22.2 No. 60950	EN 55011 (Class B), EN 55022 (Class B), EN 61000-6-2, EN 61000-3-2 (A14), EN 50081-1 UL 508 UL 60950, CAN/CSA C22.2 No. 60950
Special Application Products	Compact redundancy module for 10...60V DC Buffer module for extended ride-through Redundant power supplies Redundancy modules DC UPS DC converter			
Product Selection	Page 8-5	Page 8-6	Page 8-6	Page 8-7



Bulletin 1606 — Power Supplies*

- Quick mounting and connecting, innovative DIN-Rail mount, smallest in class
- UL Listed NEC Class 2; Class 1, Div. 2; Semi F47; ODVA Approved
- Low inrush current limiting
- PFC Active or Passive
- Wide range input; auto select input
- Superior overload design (continuous current, no hiccup)
- NEC Class 2 'Limited Power' options
- Selectable operating mode (single/parallel)
- Superior efficiency and temperature rating

Special Modules

- Brownout buffer, DC to DC converter, N+1 redundancy, DC UPS

Standards Compliance

- World-wide Certifications
- NEC Class 2
- Class 1 Div. 2 (T3A)
- cULus, CE, C-Tick
- SEMI F47 Compatible
- ABS/GL/RINA (Marine)

Table of Contents

Product Sizing..... this page

Quick Guide..... 8-4

Special Applications. 8-4

Cat. No. Explanation 8-5

Product Selection 8-5

Accessories..... 8-8

Specifications..... 8-9

Approx. Dimensions . 8-17

1606-XL

Redundancy..... 8-20

1606-XLBuffer 8-21

1606-XLS DC UPS 8-22

Certifications



* Not all features apply to all power supplies; see individual power supply descriptions for specifics

* A more detailed list of performance specifications can be found at the Allen-Bradley web site http://www.ab.com/industrialcontrols/products/power_supplies/index.html

How to Select a Bulletin 1606 Power Supply

The Bulletin 1606 line of Power Supplies is designed with "reserve power" thereby eliminating the need to oversize your power supply to start high inrush loads.

Steps to size a Power Supply

1. Determine the "Average" continuous current of the load and the typical inrush current.
2. Select a power supply where the rated load is at/or below the current of the device and the Peak Current is less than the short-circuit rating of the power supply.

Notes:

- PowerBoost will deliver up to 25% additional current continuously at 40 °C or less.
- ReservePower will deliver 150% of rated current for up to 5 s.

Example:

Application: Single Phase 120V input, 24V output, 5 A continuous current @ 35 °C, with 7.5 A inrush current

Solution: 1606-XLS120E

Output Characteristic for XLS120E (5 A) Power Supply

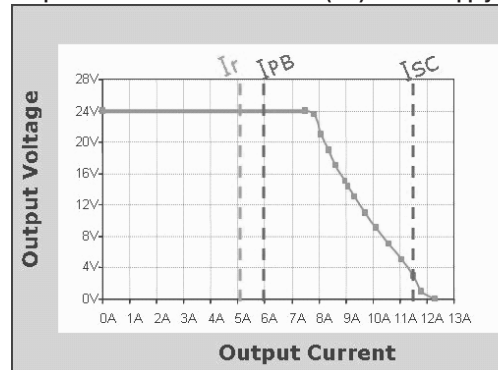

Cat. No.	I _{RATED} [A]	I _{SHORT CIRCUIT} (25 °C) [A]	I _{POWER BOOST} OR I _{RESERVEPOWER} [A]
1606-XLS80E	3.4	5.2	5.4§
1606-XLS120E	5	9	7.5§
1606-XLS240E	10	21	15§
1606-XLS480E	20	30	30§
1606-XLS480E-3	20	29	30§
1606-XLSDNET4	3.8	4	—
1606-XLSDNET8	8	7	—
1606-XLE80E	3	5.5	3.6
1606-XLE120E	5	11	6
1606-XLE240E	10	16	12
1606-XLE240EP	10	16	12
1606-XLE240F	5	8.5	6
1606-XLP15E	0.6	0.75	—
1606-XLP25A	5	5	—
1606-XLP30B	3	4	—
1606-XLP30E	1.3	1.9	—
1606-XLP36C	2.8	2	—
1606-XLP50B	4.2	4.3	—
1606-XLP50E	2.1	3.1	—
1606-XLP50EZ	2.1	3.1	—
1606-XLP50F	1	1.7	—
1606-XLP72E	3	4.5	—

Cat. No.	I _{RATED} [A]	I _{SHORT CIRCUIT} (25 °C) [A]	I _{POWER BOOST} OR I _{RESERVEPOWER} [A]
1606-XLP90B	7.5	8	—
1606-XLP90E-2	3.75	7	—
1606-XLP95E	3.9	7	—
1606-XLP100E	4.2	7.1	—
1606-XLP100E-2	4.2	8	—
1606-XLP100F	2.1	3.6	—
1606-XL60D	2.5	4.5*	—
1606-XL180B	15	21*	—
1606-XL480EPT	20	22	25
1606-XL480GP	13.3	12	16.6
1606-XL480F	10	24	12.5
1606-XL120E-3	5	11*	6
1606-XL240E-3	10	22*	12
1606-XL480E-3W	20	25	25
1606-XL480F-3H	10	N/A➤	12.5
1606-XL720E-3	30	N/A➤	33
1606-XL960E-3	40	44	45
1606-XL960E-3S	40	44	45
1606-XL60DR	2.5	4.5*	—
1606-XL120DR	5	10*	6
1606-XL240DR	10	18*	12

§ Products with ReservePower.

* Short circuit current values are temperature dependent for the selected product; i.e., the higher the ambient temperature, the lower the short circuit current.

➤ Hiccup Overload design.

Power Supplies

Selection Information, Continued/Quick Guide

Quick Guide

Bulletin 1606-(number from table) ⌘ Power Supply Quick Guide

	15...40 W	50 W	60 W	72...80 W	90...100 W	120 W	180 W	240 W	480 W	720 W	960 W
5...5.5V	XLP15A XLP25A	—	—	—	—	—	—	—	—	—	—
10...12V	XLP30B	—	—	—	—	—	—	—	—	—	—
12...15V	XLP15B	XLP50B	—	—	XLP90B	—	XL180B	—	—	—	—
(+/-)12 and 15V	XLP36C	—	—	—	—	—	—	—	—	—	—
24...28V 1-Ph	XLP15E XLP30E	XLP50E XLP50EZ	XL60D	XLS80E XLE80E XLP72E	XLP95E XLP100E	XLS120E XLE120E XLE120EC	—	XLS240E XLS240EC XLE240E XLE240EP	XLS480E XL480E XL480EP XL480EPT	—	—
24...28V 2-Ph/3-Ph	—	—	—	—	XLP90E-2 XLP100E-2	XL120E-3	—	XL240E-3 XL240E-3C	XLS480E-3 XLS480E-3C XL480E-3W	XL720E-3	XL960E-3 XL960E-3S
36...43V	—	—	—	—	—	—	—	—	XL480GP	—	—
48...56V 1-Ph	—	XLP50F	—	—	XLP100F	—	—	XLE240F XL240FP	XL480F	—	—
48...56V 3-Ph	—	—	—	—	—	—	—	—	XL480F-3H	—	—
24V Redundant	—	—	XL60DR	—	—	XL120DR	—	XLPRD XL240DR	XLSRED XLERED XLRED20-30	XLRED20-30	XLRED40
DeviceNet	—	—	—	—	XLSDNET4	—	—	XLSDNET8	—	—	—

⌘ Example: For a 24...28 Volt, 3-Phase, 120 Watt power supply, the Catalog Number would be 1606-XL120E-3.

Special Applications

NEC Class 2

- 1606-XLSDNET4
- 1606-XLE72E
- 1606-XLE80E
- 1606-XLP15A
- 1606-XLP15B
- 1606-XLP15E
- 1606-XLP25A
- 1606-XLP30B
- 1606-XLP30E
- 1606-XLP36C
- 1606-XLP50B
- 1606-XLP50E
- 1606-XLP50EZ
- 1606-XLP72E
- 1606-XLP90B
- 1606-XLP95E
- 1606-XLP90E-2
- 1606-XL60D
- 1606-XLDNET4
- 1606-XL60DR

ABS/GL/RINA (Marine)

- 1606-XLP15A
- 1606-XLP15B
- 1606-XLP15E
- 1606-XLP25A
- 1606-XLP30E
- 1606-XLP36C
- 1606-XLP50E
- 1606-XLP50EZ
- 1606-XLP72E
- 1606-XLP90B
- 1606-XLP100E
- 1606-XLP100F
- 1606-XLPRED

Hazardous Location Rating, Class 1 Div. 2

- 1606-XLP15A
- 1606-XLP15B
- 1606-XLP15E
- 1606-XLS80E
- 1606-XLS120E
- 1606-XLS240E
- 1606-XLS480E
- 1606-XLS480E-3
- 1606-XLSDNET4
- 1606-XLSDNET8
- 1606-XLSRED
- 1606-XLP25A
- 1606-XLP30B
- 1606-XLP30E
- 1606-XLP50B
- 1606-XLP50E
- 1606-XLP50EZ
- 1606-XLP72E
- 1606-XLP90B
- 1606-XLP95E
- 1606-XLP100E
- 1606-XLPRED
- 1606-XL240E
- 1606-XL240EP

ODVA Requirements

- 1606-XLSDNET4
- 1606-XLSDNET8

Conformal Coating

- 1606-XLE120EC
- 1606-XLS240EC
- 1606-XL240E-3C
- 1606-XLS480E-3C

Semiconductor F47 Sag Immunity Requirements

Product	Input Mains Voltage	Output Current Range
• 1606-XLS80E	Full Range	Full Range
• 1606-XLS120E	Full Range	Full Range
• 1606-XLS240E	Full Range	Full Range
• 1606-XLS480E	Full Range	Full Range
• 1606-XLS480E-3	Full Range	Full Range
• 1606-XLSDNET4	Full Range	Full Range
• 1606-XLSDNET8	Full Range	Full Range
• 1606-XLP30E	AC 200V or higher	Full Range up to 1.3 A
• 1606-XLP50E	AC 200V or higher	Full Range up to 2.1 A
• 1606-XLP100E	AC 200V or higher	Full Range up to 4.2 A
• 1606-XL60D	AC 120V or higher	Full Range up to 2.5 A
• 1606-XL120D	AC 120V or higher	Full Range up to 5 A
• 1606-XLDNET4	AC 120V or higher	Up to 3 A
• 1606-XL480E	AC 200V or higher	Full Range up to 20 A

Visit our website: www.ab.com/catalogs

Preferred availability cat. nos. are printed in **bold**



Allen-Bradley

Cat. No. Explanation

Important: The following cat. no. breakdown is for explanation purposes only. It is not a product configurator. Not all combinations of fields are valid product cat. nos. First, select the desired power supply using the Product Selection tables. Then, use this breakdown for verification and explanation only.

1606 – XLS 480 E – 3
 a b c d e

a

Power Supply Type	
Code	Description
XLP	Compact family
XL	Standard family
XLS	Performance family
XLE	Essential family

b

Rated Output Watts	
Code	Description
15	15 W
25	25 W
30	30 W
36	36 W
40	40 W
50	50 W
60	60 W
72	72 W
80	80 W
90	90 W
95	95 W
100	100 W
120	120 W
180	180 W
240	240 W
480	480 W
720	720 W
960	960 W

c

Output Voltage	
Code	Description
A	5V DC
B	10...12V DC or 12...15 V DC
C	Dual +/- 12 and 15V DC
D	24V DC
E	24...28V DC
F	48...56V DC
G	36...43V DC

d

Special Functions	
Code	Description
	Can be left blank
C	Conformal coating
R	Redundancy module
P	Power factor correction
L	Load sharing
T	Remote shutdown
Z	Removeable Terminations
X	Semi-Regulated
E	Regional voltage; 230V AC input only
N	Regional voltage; 120V AC input only

e

Multi-Phase Variations	
Code	Description
	Can be left blank
-2	Two phase
-3	Three phase
-3C	Three phase, conformal coating
-3H	Three phase, input voltage 400V AC and 450...700V DC
-3W	Three phase, wide input range
-3S*	Three phase, special output signals

* Special output signals are only available with the 960 W power supply.

Product Selection

1606-XLS Performance — Single- and Three-Phase

Single-Phase

Input Voltage	Input Voltage Selector	Output Power [W]	Output Voltage	Output Current [A]	Input Circuit Protection*	Inrush Current	Parallel Operation	Meets EN 61000-3-2 PFC Harmonics	DC OK Relay	Cat. No.
100...240V AC, 110...300V DC	Auto	80	24...28V DC	3.4	6 A SLOW BLOW FUSE OR 1492-SPU1C060/20 A	<7.0 A	Yes	Yes	—	1606-XLS80E
100...240V AC, 110...300V DC	Auto	120	24...28V DC	5	6 A SLOW BLOW FUSE OR 1492-SPU1C060/20 A	<4.9 A	Yes	Yes	✓	1606-XLS120E
100...240V AC, 110...300V DC	Auto	240	24...28V DC	10	6 A SLOW BLOW FUSE OR 1492-SPU1C060/20 A	<5.0 A	Yes	Yes	✓	1606-XLS240E
100...240V AC, 110...300V DC	Auto	480	24...28V DC	20	6 A SLOW BLOW FUSE OR 1489-A1C060/20 A	<9.0 A	Yes	Yes	✓	1606-XLS480E
100...240V AC, 110...300V DC	Auto	91	24V DC	3.8	6 A SLOW BLOW FUSE OR 1489-A1C060/20 A	<4.9 A	Yes	Yes	✓	1606-XLSDNET4
100...240V AC, 110...300V DC	Auto	192	24V DC	8	6 A SLOW BLOW FUSE OR 1489-A1C060/20 A	<7.6 A	Yes	Yes	✓	1606-XLSDNET8

* Unit has internal (not accessible/replaceable) input fuse. Additional protection is not required if used on branch circuits ≤ UL test levels. Consult local codes and regulations for installation.

Three-Phase

Input Voltage	Input Voltage Selector	Output Power [W]	Output Voltage	Output Current [A]	Input Circuit Protection	Inrush Current	Parallel Operation	Meets EN 61000-3-2 PFC Harmonics	DC OK Relay	Cat. No.
380...480V AC, 600V DC	Auto	480	24...28V DC	20	6 A (X3) SLOW BLOW FUSE OR 1489-SP3C060	<4.0 A	Yes	Yes	✓	1606-XLS480E-3

1606-XLE Essential — Single-Phase

Input Voltage	Input Voltage Selector	Output Power [W]	Output Voltage	Output Current [A]	Input Circuit Protection	Inrush Current	Parallel Operation+	Meets EN 61000-3-2 PFC Harmonics	DC OK Relay	Cat. No.	
100...120/200...240V AC	Auto	80	24...28V DC	3.3	10 A SLOW BLOW FUSE OR 1489-A1C100/20 A♣	<3 A	Yes	No	—	1606-XLE80E	
100...120/200...240V AC			120	24...28V DC	5	10 A SLOW BLOW FUSE OR 1489-A1C100/20 A♣	<3 A	Yes	No	—	1606-XLE120E
90...132V AC				24...28V DC	5	10 A SLOW BLOW FUSE OR 1489-A1C100/20 A♣	<3 A	Yes	No	—	1606-XLE120EN
180...264V AC		24...28V DC	5	10 A SLOW BLOW FUSE OR 1489-A1C100/20 A♣	<3 A	Yes	No	—	1606-XLE120EE		
100...120/200...240V AC		240	24	24...28V DC	10	10 A SLOW BLOW FUSE OR 1489-A1C100/20 A♣	<3 A	Yes	No	—	1606-XLE240E
90...132V AC				24...28V DC	10	10 A SLOW BLOW FUSE OR 1489-A1C100/20 A♣	<3 A	Yes	No	—	1606-XLE240EN
180...264V AC				24...28V DC	10	10 A SLOW BLOW FUSE OR 1489-A1C100/20 A♣	<3 A	Yes	No	—	1606-XLE240EE
100...120/200...240V AC			24...28V DC	10	10 A SLOW BLOW FUSE OR 1489-A1C100/20 A♣	<3 A	Yes	Yes	—	1606-XLE240EP	
100...120/200...240V AC			48...52V DC	5	10 A SLOW BLOW FUSE OR 1489-A1C100/20 A♣	<3 A	Yes	No	—	1606-XLE240F	

1606-XLP Compact — Single- and Two-Phase

Single-Phase

Input Voltage	Input Voltage Selector	Output Power [W]	Output Voltage	Output Current [A]	Input Circuit Protection	Inrush Current	Parallel Operation	Meets EN 61000-3-2 PFC Harmonics	DC OK Relay	Cat. No.
100...240V AC, 85...375V DC	Auto	15	5...5.5V DC	3	10 A SLOW BLOW FUSE OR 1489-A1C100/15 A♣	<11 A	Yes	N/A	—	1606-XLP15A
			12...15V DC	1.3					—	1606-XLP15B
			24...28V DC	0.6					—	1606-XLP15E
100...240V AC, 85...375V DC	Auto	25	5...5.5V DC	5	10 A SLOW BLOW FUSE OR 1489-A1C100/15 A♣	<18 A	Yes	N/A	—	1606-XLP25A
100...240V AC, 85...375V DC	Auto	30	10...12V DC	3	10 A SLOW BLOW FUSE OR 1489-A1C100/15 A♣	<18 A	Yes	N/A	—	1606-XLP30B
			24...28V DC	1.3					—	1606-XLP30E
100...240V AC, 85...375V DC	Auto	36	+/- 12/15V DC	2.8	10 A SLOW BLOW FUSE OR 1489-A1C100/15 A♣	<18 A	Yes	N/A	—	1606-XLP36C
100...240V AC, 85...375V DC	Auto	50	12...15V DC	4.2	10 A SLOW BLOW FUSE OR 1489-A1C100/15 A♣	<18 A	Yes	N/A	—	1606-XLP50B
			24...28V DC	2.1					✓	1606-XLP50E
			24...28V DC	2.1					✓	1606-XLP50EZ
			48...56V DC	1					—	1606-XLP50F
100...120/220...240V AC, 220...375V DC	Man.	72	24...28V DC	3	10 A SLOW BLOW FUSE OR 1489-A1C100/15 A♣	<30 A	Yes	N/A	—	1606-XLP72E
100...120/220...240V AC, 220...375V DC	Auto	90	12...15V DC	7.5	10 A SLOW BLOW FUSE OR 1489-A1C100/15 A♣	<30 A	Yes‡	Yes	—	1606-XLP90B
100...200/200...240V AC, 220...375V DC	Auto	95	24...28V DC	3.9	10 A SLOW BLOW FUSE OR 1489-A1C100/15 A♣	<30 A	Yes	Yes	—	1606-XLP95E
100...200/200...240V AC, 220...375V DC	Auto	100	24...28V DC	4.2	10 A SLOW BLOW FUSE OR 1489-A1C100/15 A♣	<30 A	Yes‡	Yes	—	1606-XLP100E
	Auto		48...56V DC	2.1	10 A SLOW BLOW FUSE OR 1489-A1C100/15 A♣	<30 A	Yes‡	Yes	—	1606-XLP100F

♣ Unit has internal (not accessible/replaceable) input fuse. Additional protection is not required if used on branch circuits ≤ UL test levels.

‡ Parallel use for 1 + 1 redundancy only.

‡ Single/parallel operation (inclined characteristic) selectable (jumper).

Consult local codes and regulations for installation.

Two-Phase

Input Voltage	Input Voltage Selector	Output Power [W]	Output Voltage	Output Current [A]	Input Circuit Protection	Inrush Current	Parallel Operation	Meets EN 61000-3-2 PFC Harmonics	DC OK Relay	Cat. No.
380...480V AC	—	90	24...28V DC	3.75	10 A (X2) SLOW BLOW FUSE OR 1489-A2C100/20 A [⚡]	<35 A	Yes‡	Yes	—	1606-XLP90E-2
380...480V AC	—	100	24...28V DC	4.2	10 A (X2) SLOW BLOW FUSE OR 1489-A2C100/20 A [⚡]	<35 A	Yes‡	Yes	—	1606-XLP100E-2

1606-XL Standard — Single- and Three-Phase

Single-Phase

Input Voltage	Input Voltage Selector	Output Power [W]	Output Voltage	Output Current [A]	Input Circuit Protection	Inrush Current	Parallel Operation	Meets EN 61000-3-2 PFC Harmonics	DC OK Relay	Cat. No.
100...120/200...240V AC, 160...375V DC	Man.	60	24V DC	2.5	10 A SLOW BLOW FUSE OR 1489-A1C100/16 A [⚡]	<18 A	Yes	Yes	—	1606-XL60D
100...200/200...240V AC, 240...375V DC	Man.	180	12...15V DC	15	10 A SLOW BLOW FUSE OR 1489-A1C100/10 A [⚡]	<21 A	Yes	No	—	1606-XL180B
200...240V AC, 270...370V DC	—	480	24...28V DC	20	10 A SLOW BLOW FUSE OR 1489-A1C100/16 A	<23 A	Yes‡	No	—	1606-XL480E
100...120/200...240V AC	Auto		24...28V DC	20	10 A SLOW BLOW FUSE OR 1489-A1C100	<18 A @ 25°C	Yes‡	Yes	—	1606-XL480EP
100...120/200...240V AC	Auto		24...28V DC	20	10 A SLOW BLOW FUSE OR 1489-A1C100	<18 A @ 25°C	Yes‡	Yes	—	1606-XL480EPT
100...120/200...240V AC	Auto		36...43V DC	13.3	10 A SLOW BLOW FUSE OR 1489-A1C100	<18 A @ 25°C	Yes‡	Yes	—	1606-XL480GP
100...120/200...240V AC	Auto		48...56V DC	10	10 A SLOW BLOW FUSE OR 1489-A1C100	<18 A @ 25°C	Yes‡	No	—	1606-XL480F

Three-Phase

Input Voltage	Output Power [W]	Output Voltage	Output Current [A]	Input Circuit Protection	Inrush Current	Parallel Operation	Meets EN 61000-3-2 PFC Harmonics	DC OK Relay	Cat. No.
400...500V AC, 450...820V DC	120	24...28V DC	5	10 A (X3) SLOW BLOW FUSE OR 1492-SP3C100	<25 A	Yes	Yes	—	1606-XL120E-3
400...500V AC, 450...820V DC	240	24...28V DC	10	6 A (X3) SLOW BLOW FUSE OR 1492-SP3C060/15 A [⚡]	<17 A	Yes‡	Yes	—	1606-XL240E-3
400...500V AC, 450...820V DC	480	24...28V DC	20	6 A (X3) SLOW BLOW FUSE OR 1492-SP3C060/16 A [⚡]	<7 A	Yes‡	Yes	—	1606-XL480E-3W
400V AC, 450...700V DC		48...56V DC	10	10 A (X3) SLOW BLOW FUSE OR 1492-SP3C100	<15 A				1606-XL480F-3H
400...500V AC, 450...820V DC	720	24...28V DC	30	10 A (X3) SLOW BLOW FUSE OR 1492-SP3C100	<17 A	Yes‡	Yes	—	1606-XL720E-3
400...500V AC	960	24...28V DC	40	10 A (X3) SLOW BLOW FUSE OR 1492-SP3C100	<30 A	Yes‡	Yes	—	1606-XL960E-3
						Active current sharing		⚡	1606-XL960E-3S

‡ Single/parallel operation (inclined characteristic) selectable (jumper).
 ⚡ Unit has internal (not accessible/replaceable) input fuse. Additional protection is not required if used on branch circuits ≤ UL test levels.
 ⚡ DC OK output is provided through a 24V DC signal.
 Consult local codes and regulations for installation.



1606 Special Modules

Input Voltage	Input Voltage Selector	Output Power [W]	Output Voltage	Output Current [A]	Input Circuit Protection	Inrush Current	Parallel Operation	Meets EN 61000-3-2 PFC Harmonics	DC OK Relay	Cat. No.
18...36V DC	—	40	5.1V DC	8	N/A	<5 A	—	No	—	1606-XLDC40A
100...240V AC, 110...300V DC	Auto	91	24V DC	3.8	6 A SLOW BLOW FUSE OR 1489-A1C060/20 A*	<4.9 A	Yes	Yes	✓	1606-XLSDNET4
100...240V AC, 110...300V DC	Auto	192	24V DC	8	6 A SLOW BLOW FUSE OR 1489-A1C060/20 A*	<7.6 A	Yes	Yes	✓	1606-XLSDNET8
100...120/200...240V AC, 160...375V DC	Man.	60	24V DC	2.5	10 A SLOW BLOW FUSE OR 1489-A1C100/16 A*	<18 A	Yes‡	N/A	✓	1606-XL60DR
100...120/200...240V AC, 210...375V DC	Man.	120		5	10 A SLOW BLOW FUSE OR 1489-A1C100/16 A*	<11 A	Yes‡	Yes	✓	1606-XL120DR
100...120/200...240V AC, 240...375V DC	Man.	240		10	10 A SLOW BLOW FUSE OR 1489-A1C100/10 A*	<21 A	Yes‡	No	✓	1606-XL240DR
24V DC	—	720	V _{in} -5V typ	30	N/A	N/A*	—	N/A	—	1606-XLRED20-30
24V DC	—	960	V _{in} -6V typ	40	N/A	N/A§	—	N/A	—	1606-XLRED40
10...60V DC	—	384	V _{in} 1 -.9V typ	16➤	N/A	N/A	—	N/A	—	1606-XLPRED
10...60V DC	—	480	V _{in} 1 -.9V typ	20➤	N/A	N/A	—	N/A	—	1606-XLSRED
24...60V DC	—	480	V _{in} 1 -.9V typ	20➤	N/A	N/A	—	—	—	1606-XLERED
—	Auto	120	24...28V DC	5	10 A SLOW BLOW FUSE OR 1489-A1C100/20 A*	<3 A	Yes	No	—	1606-XLE120EC
100...240V AC, 110...300V DC	Auto	240	24...28V DC	10	6 A SLOW BLOW FUSE OR 1489-A1C060/20 A*	<4 A	Yes	Yes	✓	1606-XLS240EC
400...500V AC, 450...820V DC	—	240	24...28V DC	10	6 A (X3) SLOW BLOW FUSE OR 1492-SP3C060/15 A*	<3 A	Yes	Yes	—	1606-XL240E-3C
—	Auto	480	24...28V DC	20	6 A (X3) SLOW BLOW FUSE OR 1492-SP3C060	<15 A	Yes	Yes	✓	1606-XLS480E-3C

1606 Special Modules with UPS

Input Voltage	Input Voltage Selector	Output Power [W]	Output Voltage	Output Current [A]	Input Circuit Protection	Inrush Current	Parallel Operation	Meets EN 61000-3-2 PFC Harmonics	DC OK Relay	Cat. No.
22.5...30V DC	—	240	22.5...30V DC	10	N/A	—	—	N/A	—	1606-XLS240-UPS
24...28.8V DC	—	480	23...27.8V DC	20	N/A	—	—	N/A	—	1606-XLBUFFER

* To be used alongside 20, 30, and 40 A power supplies.

‡ Single/parallel operation (inclined characteristic) selectable (jumper).

§ To be used alongside 40 A power supplies (or smaller).

* Unit has internal (not accessible/replaceable) input fuse. Additional protection is not required if used on branch circuits ≤ UL test levels.

➤ See product specifications for proper use.





⌘ The 1606-XLS240-UPS is a charging module, used along side a power supply and a battery assembly, which must be ordered separately. (See Accessories below.)



Consult local codes and regulations for installation.

1606 Accessories

Description	Cat. No.
Back-of-panel bracket for XL	1606-XLA
Back-of-panel bracket for XLS or XLE	1606-XLB
7 Ah/12V battery assembly with bracket, for use with DC UPS	1606-XLSBATASSY1
7 Ah/12V battery	1606-XLSBAT1
Battery bracket for 7 Ah/12V battery	1606-XLSBATBR1
26 Ah/12V battery assembly with bracket, for use with DC UPS	1606-XLSBATASSY2
26 Ah/12V battery	1606-XLSBAT2
Battery bracket for 26 Ah/12V battery	1606-XLSBATBR2

1606-XLS Performance Specifications

					
	1606-XLS80E	1606-XLS120E	1606-XLS240E and 1606-XLS240EC [‡]	1606-XLS480E	1606-XLS480E-3 and 1606-XLS480E-3C [‡]
Output Volts/Watts	24...28V/80 W	24...28V/120 W	24...28V/120 W	24...28V/480 W	24...28V/480W
Input Voltage (47...63 Hz)	100...240V AC, 110...300V DC	100...240V AC, 110...300V DC	100...240V AC, 110...300V DC	100...240V AC, 110...300V DC	380...480V AC, 600V DC
Operational Range	85...276V AC, 88...375V DC	85...264V AC, 88...360V DC	85...276V AC, 88...375V DC	85...276V AC, 88...375V DC	323...552V AC, 450...780V DC
Hold-up Time	27...174 ms	33...59 ms	27 ms	32...51 ms	19 ms
Rated Input Current	1.4 A (100V AC), 0.82 A (240V AC)	1.4 A (100V AC), 0.65 A (240V AC)	2.8 A (100V AC), 1.2 A (240V AC)	4.6 A (100V AC), 2.5 A (240V AC)	0.9 A (380V AC), 0.65 A (480V AC)
Efficiency	typ. 90.0%	typ. 92.7%	typ. 91.8%	typ. 92.4%	typ. 94.8%
Output Voltage	24...28V	24...28V	24...28V	24...28V	24...28V
Rated Output Current	3.4 A (@ 24V) 3.0 A (@ 28V)	5 A (@ 24V) 4.5 A (@ 28V)	10 A (@ 24V) 9 A (@ 28V)	20 A (@ 24V) 17 A (@ 28V)	20 A (@ 24V) 17.5 A (@ 28V)
ReservePower (typ. 4 s)	5.4 A (@ 24V) 5.0 A (@ 28V)	7.5 A (@ 24V) 6.7 A (@ 28V)	15 A (@ 24V) 13.5 A (@ 28V)	30 A (@ 24V) 26 A (@ 28V)	30 A (@ 24V) 26 A (@ 28V)
Ripple/Noise	<100 mV _{pp}	<50 mV _{pp}	<50 mV _{pp}	<100 mV _{pp}	<100 mV _{pp}
Operating Temperature Range (T _{amb})	-25...+70 °C >60 °C with derating				
Non-Operating Temperature Range	-40...+85 °C				
MTBF [‡]	>650 000 hours	>831 000 hours	>581 000 hours	>469 000 hours	>690 000 hours
Dimensions (W x H x D)	32 x 124 x 102 mm	40 x 124 x 117 mm	60 x 124 x 117 mm	84 x 124 x 127 mm	65 x 124 x 127 mm
Weight	420 g	620 g	900 g	1200 g	870 g
Certifications/Standards*	1, 2, 3, 5, 6, 7				
Special Features	Active PFC; Class 1 Div. 2; Semi F47				

		
	1606-XLSDNET4	1606-XLSDNET8
Output Volts/Watts	24V/91 W	24V/192 W
Input Voltage (47...63 Hz)	100...240V AC; 110...300V DC	
Operational Range	85...264V AC 88...360V DC	85...276 V AC 88...375 V DC
Hold-up Time	43 ms (120V AC) 77 ms (240V AC)	38 ms (120V AC) 41 ms (240V AC)
Rated Input Current	1.1 A (100V AC) 0.5 A (240V AC)	2.3 A (100V AC) 1.0 A (240V AC)
Efficiency	typ. 92.4%	typ. 92.7%
Output Voltage	24V	
Rated Output Current	3.8 A	8 A
Ripple/Noise	< 50 mV _{pp}	
Operating Temperature Range (T _{amb})	-25...+70 °C >60 °C with derating	
Non-Operating Temperature Range	-40...+85 °C	
MTBF [‡]	>581 000 hours	>831 000 hours
Dimensions (W x H x D)	40 x 124 x 117 mm	60 x 124 x 117 mm
Weight	620 g	900 g
Certifications/Standards*	1, 2, 3, 5, 6, 7	
Special Features	NEC Class 2 power supply; Active PFC; ODVA Approved; Class 1 Div. 2; Semi F47	Active PFC; ODVA Approved; Class 1 Div. 2; Semi F47

* 1) = CE, 2) = UL 508 (cULus LISTED), 3) = UL 1950 (cURus), 5) Safety standards = IEC/EN 60950, EN 50178, 6) EMC standards = EN 55011 (Class B), EN 55022 (Class B), EN 61000-6-2, 7) EMC standards = EN 61000-3-2 (A14), EN 50081-1

‡ MTBF determined by Siemens norm SN 29500 at full load current and 40 °C

‡ Because these catalog numbers end with "C", it indicates these devices have conformal coating.

1606-XLE

	1606-XLE80E	1606-XLE120E❖ and 1606-XLE120EC‡	1606-XLE240E❖	1606-XLE240EP	1606-XLE240F
Output Volts/Watts	24V...28V/80 W	24V...28V/120 W	24V...28V/240 W	24V...28V/240 W	48V...52V/240 W
Input Voltage (47...63Hz)	AC 100...120V/200...240V				
Operational Range	90...132V/180...264V AC				
Hold-up Time	>60 ms (120V) >244 ms (240V)	>80 ms (120V) >78 ms (240V)		>46 ms (120V) >42 ms (240V)	
Rated Input Current	20 A (100V AC) 45 A (240V AC)	2.6 A (100V AC) 1.3 A (240V AC)		5 A (100V AC) 2.5 A (240V AC)	
Efficiency	typ. 90%	typ. 90%	typ. 91%	typ. 91%	typ. 92%
Output Voltage	24...28V				48...52V
Rated Output Current	3.3 A @ 24V 2.9 A @ 28V	5 A @ 24V 4.3 A @ 28V	10 A @ 24V 8.6 A @ 28V		5 A @ 48V 4.6 A @ 52V
Ripple/Noise	<50 mV _{pp}				
Operating Temperature Range (T_{amb})	-25...+70 °C, >60 °C with derating				
Non-Operating Temperature Range	-40...+85 °C				
MTBF§	>700 000 hours				
Dimensions (W x H x D)	32 x 124 x 102 mm	32 x 124 x 117 mm	60 x 124 x 117 mm		
Weight	430 g	500 g	700 g	800 g	700 g
Certifications/Standards*	1, 2, 3, 4, 5, 6, 7				
Special Features	NEC Class 2		—		

* 1) = CE, 2) = UL 508 (cULus LISTED), 3) = UL 1950 (cURus), 4) = CSA C22.2, No. 107-1, 5) Safety standards = IEC/EN 60950, EN 50178, 6) EMC standards = EN 55011 (Class B), EN 55022 (Class B), EN 61000-6-2, 7) EMC standards = EN 61000-3-2 (A14), EN 50081-1





§ MTBF determined by Siemens norm SN 29500 at full load current and 40 °C

‡ Because this catalog number ends with **C**, it indicates the device has conformal coating.

❖ Available in regional voltages: add **N** to the end of the cat. no. for 90...132V, or add **E** to the end of the cat. no. for 180...264V.







1606-XLP Compact Specifications

				
	1606-XLP15A	1606-XLP15B	1606-XLP15E	1606-XLP25A
Output Volts/Watts	5...5.5V/15 W	12...15V/15 W	24...28V/15 W	5...5.5V/25 W
Input Voltage (47...63 Hz)	100...240V AC wide range; 85...370V DC			
Operational Range	85...264V AC			
Hold-up Time	>168 ms (230V AC) >45 ms (100V AC)	>191 ms (230V AC) >46 ms (100V AC)	>196 ms (230V AC) >47 ms (100V AC)	>170 ms (230V AC) >19 ms (100V AC)
Rated Input Current	<0.28 A (100V AC) <0.17 A (196V AC)			<0.5 A (100V AC) <0.35 A (196V AC)
Efficiency	typ. >77%	typ. >83%	typ. >88%	typ. >80%
Output Voltage	5...5.5V 5.1V preset	12...15V	24...28V	5...5.5V 5.1V preset
Rated Output Current	0.54...0.63 A	3 A	1.0...1.3 A	5 A (at 5.1V), 4.5 A (at 5.5V)
Ripple/Noise	<50 mV _{pp}	<75 mV _{pp}	<50 mV _{pp}	<50 mV _{pp}
Operating Temperature Range (T_{amb})	-10...+70 °C, >60 °C: 0.4 W/K derating			-10...+70 °C >60 °C: 0.5 W/K derating
Non-Operating Temperature Range	-40...+85 °C			
MTBF*	2 686 000 hours	3 811 000 hours	4 369 000 hours	600 000 hours
Dimensions (W x H x D)	22.5 x 75 x 91 mm			45 x 75 x 91 mm
Weight	130 g			240 g
Certifications/Standards*	1, 2, 4, 5, 7			
Special Features	NEC Class 2 power supply; ABS/GL/RINA (Marine); Class 1 Div. 2			





				
	1606-XLP30B	1606-XLP30E	1606-XLP36C	1606-XLP50B
Output Volts/Watts	10...12V/30 W	24...28V/30 W	±12V/±15V/36 W	12...15V/50 W
Input Voltage (47...63 Hz)	100...240V AC wide range; 85...375V DC		100...240V AC wide range; 85...375V DC	100...240V AC wide range; 85...375V DC
Operational Range	85...264V AC			
Hold-up Time	>170 ms (230V AC) >18 ms (100V AC)	>190 ms (230V AC) >19 ms (100V AC)	>180 ms (230V AC) >18 ms (100V AC)	>170 ms (230V AC) >17 ms (100V AC)
Rated Input Current	<0.6 A (100V AC) <0.25 A (240V AC)	<0.6 A (100V AC) <0.35 A (196V AC)	<0.65 A (AC 100V AC) <0.4 A (AC 196V AC)	<1.0 A (100V AC) <0.6 A (196V AC)
Efficiency	typ. 84%	typ. 87.5%	typ. 86%	typ. 90%
Output Voltage	10...12V 12V preset (with jumper), 10...12V adjustable (without jumper)	24...28V 24.5V preset	±12V (without jumper), ±15V (with jumper) ±15V preset	12...15V 15V preset (with jumper) 12...15V adjustable (without jumper)
Rated Output Current	3 A (@ 10V), 2.5 A (@ 12V)	1.3 A (@ 24.5V), 1 A (@ 28V)	0...2.8 A (@ +12V), 0...1.4 A (@ -12V), 0...2.4 A (@ +15V), 0...1.4 A (@ -15V)	4.2 A (@ 12V), 3.4 A (@ 15V)
Ripple/Noise	<10 mV _{pp}	<50 mV _{pp}	<50 mV _{pp}	<100mV _{pp}
Operating Temperature Range (T_{amb})	-10...+70 °C >60 °C: 0.6 W/K derating	-10...+70 °C >60 °C: 0.5 W/K derating	-10...+70 °C > 60 °C: 1 W/K derating	-10...+70 °C >60 °C: 1 W/K derating
Non-Operating Temperature Range	-10...+70 °C >60 °C: 0.6 W/K derating	-10...+70 °C >60 °C: 0.5 W/K derating	-10...+70 °C > 60 °C: 1 W/K derating	-10...+70 °C >60 °C: 1 W/K derating
MTBF*	appr. 650 000 hours		600 000 hours	appr. 600 000 hours
Dimensions (W x H x D)	45 x 75 x 91 mm			
Weight	250 g	230 g	240 g	260 g
Certifications/Standards*	1, 2, 4, 5, 7			
Special Features	NEC Class 2 power supply; Class 1 Div. 2	NEC Class 2 power supply; Class 1 Div. 2; Semi F47	Output voltage adjustable: DC ±12V without jumper or DC ±15V with jumper; NEC Class 2 power supply; ABS/GL/RINA (Marine); Class 1 Div. 2	Output voltage adjustable: DC 12...15V without jumper or DC 15V with jumper; NEC Class 2 power supply; Class 1 Div. 2

* 1) = CE, 2) = UL 508 (cULus LISTED), 3) = UL 1950 (cURus), 4) = CSA C22.2, No. 60950, 5) Safety standards = IEC/EN 60950, EN 50178, 6) EMC standards = EN 55011 (Class B), EN 55022 (Class B), EN 61000-6-2, 7) EMC standards = EN 61000-3-2 (A14), EN 50081-1
 * MTBF determined by Siemens norm SN 29500 at full load current and 40 °C

1606-XLP Compact Specifications, Continued







						
	1606-XLP50E	1606-XLP50EZ	1606-XLP50F	1606-XLP72E	1606-XLP90B	1606-XLP90E-2
Output Volts/Watts	24...28V/50 W		48...56V/50 W	24...28V/72 W	12...15V/90 W	24...28V/90 W
Input Voltage (47...63 Hz)	100...240V AC wide range; 85...375V DC			100...120/220...240V AC manual select; 220...375V DC	100...120/220...240V AC; 220...375V DC	2Ø, 380...480V AC
Operational Range	85...264V AC			85...132/184...264V AC		323...552V AC
Hold-up Time	>171 ms (230V AC) >17 ms (100V AC)		>170 ms (230V AC) >17 ms (100V AC)	>40 ms (230V AC) >25 ms (100V AC)	>40 ms (230V AC) >20 ms (196V AC, 100V AC)	>52 ms (400V) >93 ms (480V)
Rated Input Current	<1.0 A (100V AC) <0.6 A (196V AC)			<1.6 A (100V AC) <0.8 A (220V AC)	<1.9 A	<0.42 A (400V) <0.36 A (480V)
Efficiency	typ. 88.5%		typ. 90%	typ. 89%	typ. 88.5%	typ. 89%
Output Voltage	24...28V 24.5V preset		48...56V 48V preset	24...28V 24.5V preset (at 2.9 A)	12...15V Preset at 12V	24...28V Preset at 24.5V
Rated Output Current	2.1 A (@ 24.5V), 1.8 A (@ 28V)		1.05 A (@ 48V), 0.9 A (@ 56V)	3 A (@ 24V), 2.6 A (@ 28V)	7.5 A (@ 12V), 6 A (@ 15V)	3.75 A (@ 24V), 3.2 A (@ 28V)
Ripple/Noise	<50 mV _{pp}		<200 mV _{pp}	<50 mV _{pp}	<50 mV _{pp}	<50 mV _{pp}
Operating Temperature Range (T _{amb})	-10...+70 °C >60 °C: 1 W/K derating			-10...+70 °C >60 °C: 1.5 W/K derating	-10...+70 °C >60 °C: 1 W/K derating	-10...+70 °C >60 °C: 2 W/K derating
Non-Operating Temperature Range	-40...+85 °C					
MTBF*	appr. 600 000 hours			appr. 600 000 hours	appr. 500 000 hours	appr. 500 000 hours
Dimensions (W x H x D)	45 x 75 x 91 mm			45 x 75 x 91 mm	73 x 75 x 103 mm	73 x 75 x 103 mm
Weight	240 g			260 g	360 g	360 g
Certifications/Standards*	1, 2, 3, 4, 5, 6			1, 2, 3, 4, 5, 6	1, 2, 3, 4, 5, 6, 7	1, 2, 3, 4, 5, 6, 7
Special Features	NEC Class 2 power supply; ABS/GL/RINA (Marine); Class 1 Div. 2; Semi F47	Removeable Terminations; NEC Class 2 power supply; ABS/GL/RINA (Marine); Class 1 Div. 2	NEC Class 2 power supply	NEC Class 2 power supply; ABS/GL/RINA (Marine); Class 1 Div. 2	NEC Class 2 power supply; ABS/GL/RINA (Marine); Class 1 Div. 2	NEC Class 2 power supply

8

				
	1606-XLP95E	1606-XLP100E	1606-XLP100F	1606-XLP100E-2
Output Volts/Watts	24...28V/95 W	24...28V/100 W	48...56V/100 W	24...28V/100 W
Input Voltage (47...63 Hz)	100...120/220...240V AC auto select; 220...375V DC			2Ø, 380...480V AC
Operational Range	85...132/184...264V AC			323...552V AC
Hold-up Time	>40 ms (230V AC) >20 ms (100V AC)			>48 ms (400V) >85 ms (480V)
Rated Input Current	<2.0 A (100V AC) <0.95 A (220V AC)	<2.1 A (100V AC) <1.0 A (220V AC)		<0.46 A (400V) <0.40 A (480V)
Efficiency	typ. 90%		typ. 91%	typ. 89%
Output Voltage	24...28V 24.5V preset		48...56V 48V preset	24...28V Preset at 24.5V
Rated Output Current	3.9 A (@ 24.5V), 3.2 A (@ 28V)	4.2 A (@ 24.5V), 3.6 A (@ 28V)	2.1 A (@ 48V), 1.8 A (@ 56V)	4.2 A (@ 24V), 3.6 A (@ 28V)
Power Boost	—			
Ripple/Noise	<50 mV _{pp}		<50 mV _{pp}	<50 mV _{pp}
Operating Temperature Range (T _{amb})	-10...+70 °C >60 °C: 2 W/K derating			
Non-Operating Temperature Range	-40...+85 °C			
MTBF*	appr. 500 000 hours			
Dimensions (W x H x D)	73 x 75 x 103 mm			
Weight	360 g			
Certifications/Standards*	1, 2, 3, 4, 5, 6, 7			
Special Features	NEC Class 2 power supply; Class 1 Div. 2	Single/parallel operation (inclined characteristic) select on front panel; ABS/GL/RINA (Marine); Class 1 Div. 2; Semi F47		Single/parallel operation (inclined characteristic) select on front panel; ABS/GL/RINA (Marine)

* 1) = CE, 2) = UL 508 (cULus LISTED), 3) = UL 1950 (cURus), 4) = CSA C22.2, No. 60950, 5) Safety standards = IEC/EN 60950, EN 50178, 6) EMC standards = EN 55011 (Class B), EN 55022 (Class B), EN 61000-6-2, 7) EMC standards = EN 61000-3-2 (A14), EN 50081-1
 * MTBF determined by Siemens norm SN 29500 at full load current and 40 °C

1606-XL Single Phase Specifications







						
	1606-XL60D	1606-XL180B	1606-XL480EP	1606-XL480EPT	1606-XL480GP	1606-XL480F
Output Volts/Watts	24V/60 W	12...15V/180 W	24...28V/480 W		36...43V/480 W	48...56V/480 W
Input Voltage (47...63 Hz)	100...120/200...240V AC manual select; 160...375V DC	100...120/220...240V AC 240...375V DC	100...120/200...240V AC			
Operational Range	85...132/176...264V AC	85...132/176...264V AC	85...132/184...264V AC			
Hold-up Time	>20 ms (196V AC)	>81 ms (230V AC) >84 ms (120V AC) >45 ms (100V AC)	30 ms (120/230V AC)		>27 ms (230V AC)	30 ms (230V AC)
Rated Input Current	<1.3 A (115V)/<0.7A (230V)	<5A (115V)/<2.3 A (230V)	10 A (115V)/5 A (230V)			
Efficiency	typ. 87.5%	typ. >87%	typ. 90.5%		typ. 92%	typ. 93%
Output Voltage	24V	12...15V Preset at 12V	24...28V Front panel potentiometer		36...43V Front panel potentiometer	48...56V Front panel potentiometer
Rated Output Current	2.5 A	15 A (@ 12V), 12 A (@ 15V)	20 A (@ 24V), 18 A (@ 28V)		13.3 A (@ 36V), 11.2 A (@ 43V)	10 A (@ 48V), 8.6 A (@ 56V)
Power Boost	—	18 A	25 A (22 A)		16.6 A (14 A)	12.5 A (10.7 A)
Ripple/Noise	<25 mV _{pp}	<50 mV _{pp}	< 20 mV _{pp} (single operation) <40 mV _{pp} (parallel operation)		<30 mV _{pp} (single operation) <80 mV _{pp} (parallel operation)	<40 mV _{pp} (single operation) <80 mV _{pp} (parallel operation)
Operating Temperature Range (T_{amb})	-10...+70 °C >60 °C with derating	0...70 °C >60 °C with derating	0...+70 °C >60 °C with derating			
Non-Operating Temperature Range	-40...+85 °C	0...70 °C >60 °C with derating	-40...+85 °C			
MTBF*	740 000 hours	<425 000 hours	519 000 hours			
Dimensions (W x H x D)	49 x 124 x 102 mm	120 x 124 x 102 mm	220 x 124 x 102 mm			
Weight	460 g	980 g	2500 g			1800 g
Certifications/Standards*	1, 2, 3, 4, 5, 6, 7	1, 2, 3, 4, 5, 6	1, 2, 3, 4, 5, 6, 7			1, 2, 3, 4, 5, 6
Special Features	NEC Class 2 power supply; Semi F47	—	PFC choke; Overload behavior selectable; (hiccup/continuous current); ‡	PFC choke; ‡	Selectable single/parallel operation (inclined characteristic); PFC choke; ‡	‡

* 1) = CE, 2) = UL 508 (cULus LISTED), 3) = UL 1950 (cURus), 4) = CSA C22.2, No. 60950, 5) Safety standards = IEC/EN 60950, EN 50178, 6) EMC standards = EN 55011 (Class B), EN 55022 (Class B), EN 61000-6-2, 7) EMC standards = EN 61000-3-2 (A14), EN 50081-1

‡ Low inrush current

* MTBF determined by Siemens norm SN 29500 at full load current and 40 °C

1606-XL Three Phase Specifications

						
	1606-XL120E-3	1606-XL240E-3 and 1606-XL240E-3C	1606-XL480F-3H	1606-XL720E-3	1606-XL960E-3	1606-XL960E-3S
Output Volts/Watts	24...28V/120 W	24...28V/240 W	48...56V/480 W	24...28V/720 W	24...28V/960 W	
Input Voltage (47...63 Hz)	3Ø, 400...500V AC wide range; 450...820V DC	3Ø, 400...500V AC wide range; 450...820V DC	3Ø, 400V AC; 450...700V DC	3Ø, 400...500V AC wide range; 450...820V DC	3Ø, 400...500V AC wide range	
Operational Range	340...576V AC		340...479V AC	340...576V AC		
Hold-up Time	>16 ms (3Ø 400V AC) >10 ms (2Ø 400V AC)	>24 ms (3Ø 400V AC) >20 ms (2Ø 400V AC)	>11 ms	>10 ms (3Ø 400V AC)	>15 ms (3Ø 400V AC)	
Rated Input Current	3 x 0.5 A	3 x 0.8/0.7 A @ 400/500V	3 x 1.5 A	3 x 2.0 A	3 x 3.0 A	
Efficiency	typ. 89%	typ. 92%	typ. 92%	typ. 92.5%	typ. 92.5%	
Output Voltage	24...28V 24.5V preset	24...28V 24.5V preset	48...56V 48.1V preset	24...28V front panel potentiometer	24...28V front panel potentiometer	
Rated Output Current	5 A (@ 24V), 4.3 A (@ 28V)	10 A (@ 24V), 8.6 A (@ 28V)	10 A (@ 48V), 9 A (@ 56V)	30 A (@ 24V), 26 A (@ 28V)	40 A (@ 24V), 35 A (@ 28V)	
Power Boost	6 A	12 A (up to 288 W)	12.5 A	33 A	45 A	
Ripple/Noise	<25 mV _{PP}	<30 mV _{PP}	<50 mV _{PP}	<20 mV _{PP} (single operation) <40 mV _{PP} (parallel operation)	<50 mV _{PP}	
Operating Temperature Range (T_{amb})	-10...+70 °C >60 °C with derating	0...+70 °C >60 °C with derating	0...+70 °C >60 °C with derating			
Non-Operating Temperature Range	-40...+85 °C			-40...+85 °C		
MTBF*	410 000 hours	543 000 hours (3Ø), 525 000 hours (2Ø)	310 000 hours	425 000 h @ 400V AC, 360 000 h @ 480V AC	305 000 hours	268 000 hours
Dimensions (W x H x D)	73 x 124 x 117 mm	89 x 124 x 117 mm	220 x 124 x 102 mm	240 x 124 x 112 mm	275 x 124 x 117 mm	
Weight	730 g	980 g	1800 g	2000 g	3300 g	
Certifications/Standards*	1, 2, 3, 4, 5, 6, 7					
Special Features	PFC choke	Overload behavior selectable (FUSE Mode/continuous current); 2-phase operation admissible, Single/parallel operation (inclined characteristic); PFC choke; ‡	Single/parallel operation (inclined characteristic) selectable (jumper); PFC choke; ‡	PFC choke; ‡	Single/parallel operation (inclined characteristic) selectable (jumper); passive load sharing; PFC choke; ‡	Parallel operation through active current sharing; Output signals (Power-Fail, Shut-Down, internal current measurement, overtemperature warning); PFC choke; ‡

* 1) = CE, 2) = UL 508 (cULus LISTED), 3) = UL 1950 (cURus), 4) = CSA C22.2, No. 60950, 5) Safety standards = IEC/EN 60950, EN 50178, 6) EMC standards = EN 55011 (Class B), EN 55022 (Class B), EN 61000-6-2, 7) EMC standards = EN 61000-3-2 (A14), EN 50081-1

‡ Low inrush current

* MTBF determined by Siemens norm SN 29500 at full load current and 40 °C

‡ Because this catalog number ends with "C", it indicates the device has conformal coating.

"Shut Down" Input

Function: Turning the unit on or off using logic signal (remote monitoring). Unit switches off when input is connected to "Signal GND" terminal (DU ≤ 1V) or the input has a voltage of +20...28V with respect to the "Signal GND" terminal, (max. 20 mA).

"DC Ok" Output

Function: Indicating whether the unit is operating properly. Output can directly energize a relay or a control light.
Signaling: Output signal is at a "high" level (24V, current source) in normal operation (no overload, overheating, short circuit). When the output signal switches to "low" level (no power at output), Vout remains for 5 ms (nominal) at nominal load.
Connection (signal common): Connection is made with respect to the "Signal GND" terminal (signal output).
Important: Do not connect to the power output (terminals + and -).

Permissible load: resistance - min. 300 Ω, e.g. 24V relay, control lights (LEDs need no series resistance), Evaluation logic.

For 5V signal: In order to receive a 5V signal: switch a 5V Zener diode (0.5 W) and 1 kΩ, resistance in parallel between this output and the "Signal GND" terminal.

"Thermal Alarm" Output

Function: Output gives warning shortly before and while overtemperature state occurs. Output can directly control a relay or a control light.
Signaling: Output signal is at a "high" level (24V, current source) in normal operation (no overtemperature). At overtemperature, the output switches to "low". Only when the temperature in the unit increases further will the unit reduce its output current (power output).
Connection and permissible load: same as for "DC ok" output.

"Current Monitor" Output

Function: Measuring the output current (power output). Output signal is proportional to the output current of the unit.

Connection: Made with respect to the "Signal GND" terminal (signal output).
Important: Do not connect to the power output (terminals + and -).

Signaling: Voltage measuring: Voltage at signal output is 1V per 10 A output current (Ri(voltmeter) > 100 k ohm)
 Current measurement: Current at signal output is 1 mA per 10 A output current (Ri(ammeter) < 100 W)

"Current Balance" In-/Output

Function: Using these terminals, parallel operating units ensure an equal load sharing (active balancing). Balancing also works reliably with decoupling diodes at the power output (redundancy).



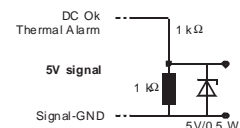
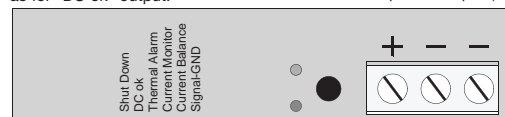

Connection: Connect together "Current Balance" outputs of all units involved.
Important: Signal common here is the - terminal of the power output, not the "Signal GND". Do not connect the "Signal GND" terminals to each other!

"Signal GND" Terminal

Function: Grounding terminal for all signal terminals (not for "Current Balance").
Connection instructions: Do not connect this terminal with terminals + or - of the unit (not even over a load: risk of overload). Do not connect this terminal with terminals of other units (not even with the "Signal GND" terminal of another unit).
Permissible load: Maximum current load: 0.3 A. Terminal is fused internally with a self-healing fuse (polyswitch).



1606-XL Special Modules







					
	Buffer Module	UPS	DC/DC Converter	N+1 Redundancy	N+1 Redundancy
	1606-XLBUFFER	1606-XLS240-UPS	1606-XLDC40A	1606-XL60DR	1606-XL120DR
Output Volts/Watts	22.5V...27.8V/480 W	22.5V...30V/240 W	DC 5.1V ±1%	24V/60 W	24V/120 W
Input Voltage (47...63 Hz)	24V DC (24...28.8V DC)	24V DC (22.5...30V DC)	18...36V DC	100...120V/200...240V AC manual select; 160...375V DC	100...120/200...240V AC manual select; 210...375V DC
Operational Range	23...35V DC	22.5...30V DC	18...36V DC	—	85...132/176...264V AC
Hold-up Time	>0.2 s (20 A)	battery dependent	>10 ms (DC 24 Vin)	>20 ms (AC 196V)	>37 ms (AC 196V)
Rated Input Current	charging current <600 mA	<0.12 A (standby) <1.3 A (charging)	<2.9 A/<1.5 A	<1.3 A (115V)/<0.7 A (230V)	<2.6 A (115V)/<1.4 A (230V)
Efficiency	N/A	N/A	typ. 82%	typ. 86.5%	typ. 89%
Output Voltage	Vin -1V: 23...27.8V 22.5V fixed	22.4V	5.1V DC ±1% selectable 4.5...5.5V	24V	24V
Rated Output Current	0...20 A	10 A	8 A	2.5 A	5 A
Power Boost	—	15 A	—	—	6 A
Ripple/Noise	<200 mV _{PP}	—	<50 mV _{PP}	<30 mV _{PP}	<30 mV _{PP}
Operating Temperature Range (T_{amb})	-10...+70 °C >60 °C with derating	-25...+60 °C	0...+70 °C >60 °C with derating	-10...+70 °C >60 °C with derating	-10...+70 °C >60 °C with derating
Non-Operating Temperature Range	-40...+85 °C				-40...+85 °C
MTBF§	480 000 hours	—	510 000 hours	700 000 hours	480.000 hours
Dimensions (W x H x D)	64 x 124 x 102 mm	49 x 124 x 117	49 x 124 x 102 mm	49 x 124 x 102 mm	64 x 124 x 102 mm
Weight	740 g	530 g	470 g	470 g	620 g
Certifications/Standards*	1, 2, 3, 5, 6	1, 2, 3, 5, 6	1, 5, 6	1, 2, 3, 5, 6	1, 2, 3, 5, 6, 7
Special Features	Selectable buffered voltage; ‡	Inhibit replacement battery buffering	MOSFET inverse battery protection; ‡	RDY relay contact; N+1 redundancy; plug connectors; NEC Class 2 power supply	RDY relay contact; N+1 redundancy; plug connectors

* 1) = CE, 2) = UL 508 (cULus LISTED), 3) = UL 1950 (cURus), 5) Safety standards = IEC/EN 60950, EN 50178, 6) EMC standards = EN 55011 (Class B), EN 55022 (Class B), EN 61000-6-2, 7) = EMC standards = EN 61000-3-2 (A14), EN 50081-1

‡ Low inrush current

§ MTBF determined by Siemens norm SN 29500 at full load current and 40 °C

1606-XL Special Modules, Continued

						
	N+1 Redundancy	N+1 Redundancy	N+1 Redundancy	N+1 Redundancy	N+1 Redundancy	
	1606-XL240DR	1606-XLRED20-30	1606-XLRED40	1606-XLPRED	1606-XLSRED	1606-XLERED
Output Volts/Watts	24V/240 W	30 A Dual redundancy module	40 A Single redundancy module	10 A Dual redundancy	20 A Dual redundancy	
Input Voltage (47...63 Hz)	AC 100...120/200...240V manual select; DC 240...375V	DC 24V (max. 35V)		DC 10...60V	DC 10...60V	
Operational Range	85...132/176...264 V AC	18...36 V DC		10...60V DC	10...60V DC	
Hold-up Time	>25 ms (AC 196V)	—	—	—	—	
Rated Input Current	<6 A (115V)/<2.8 A (230V)	20...30 A (max. 35 A)	0...40 A (max. 50 A)	Single input: 10 A max. Dual input: 16 A max. total	Single input: 20 A max. Dual input: 20 A max. total	
Efficiency	typ. 89%	typ. >97%	typ. >97%	—	—	
Output Voltage	24V	Vin -0.5V typ.	Vin -0.6V typ.	Vin -0.9V typ.	Vin -0.9V typ.	
Rated Output Current	10 A	20...30 A (max. 35 A)	0...40 A (max. 50 A)	0...10 A	0...20 A	
Power Boost	12 A	—	—	—	—	
Ripple/Noise	<30 mV _{pp}	—	—	—	—	
Operating Temperature Range (T_{amb})	0...+70 °C >60 °C with derating	-10 °C...+70 °C		-40 °C...+70 °C >60 °C with derating	-25 °C...+70 °C >60 °C with derating	
Non-Operating Temperature Range	-40...+85 °C					
MTBF§	390.000 hours	—	—	—	—	
Dimensions (W x H x D)	120 x 124 x 102 mm	48 x 124 x 102 mm	48 x 124 x 117 mm	45 x 75 x 91 mm	32 x 124 x 102 mm	32 x 124 x 117 mm
Weight	980 g	625 g	646 g	136 g	290 g	350 g
Certifications/Standards*	1, 2, 3, 5, 6	1, 2, 3, 6		1, 2, 3, 6	1, 2, 3, 6	
Special Features	RDY relay contact; N+1 redundancy; plug connectors	Dual redundancy module for 2x35 A; N+1 redundancy	Single redundancy module for 2.5-50 A; N+1 redundancy	Redundancy for DC 10...60V applications; ABS/GL/RINA (Marine); Class 1 Div. 2	Redundancy for DC 10...60V applications; Class 1 Div. 2	Redundancy for DC 10...60V applications; Class 1 Div. 2; DC OK

* 1) = CE, 2) = UL 508 (cULus LISTED), 3) = UL 1950 (cURus), 5) Safety standards = IEC/EN 60950, EN 50178, 6) EMC standards = EN 55011 (Class B), EN 55022 (Class B), EN 61000-6-2, 7) = EMC standards = EN 61000-3-2 (A14), EN 50081-1
 § MTBF determined by Siemens norm SN 29500 at full load current and 40 °C

Bulletin 1606 Dimensions Table

Approximate dimensions are shown in inches (mm) unless otherwise indicated. Dimensions are not to be used for manufacturing purposes.

Catalog Number	W [in. (mm)]	H [in. (mm)]	D [in. (mm)]*	Wire Size* (Input and Output unless otherwise noted)	
1606-XLS80E	1.26 (32)	4.88 (124)	4.02 (102)	Input* Stranded 20...10 AWG (0.5...4 mm ²) Solid 20...10 AWG (0.5...6 mm ²) Output* Stranded 28...12 AWG (0.3...2.5 mm ²) Solid 28...12 AWG (0.3...4 mm ²)	
1606-XLS120E					
1606-XLSDNET4	1.57 (40)	4.88 (124)	4.61 (117)		
1606-XLS240E	2.36 (60)	4.88 (124)	4.61 (117)	Input/Output* Stranded 20...10 AWG (0.5...4 mm ²) Solid 20...10 AWG (0.5...6 mm ²)	
1606-XLS240EC					
1606-XLS480E	3.31 (84)	4.88 (124)	4.61 (117)		
1606-XLS480E-3	2.56 (65)	4.88 (124)	5.00 (127)		
1606-XLS480E-3C					
1606-XLSDNET8	2.36 (60)	4.88 (124)	4.61 (117)		
1606-XLSRED	1.26 (32)	4.88 (124)	4.02 (102)		
1606-XLE80E	1.26 (32)	4.88 (124)	4.02 (102)		
1606-XLE120E	1.26 (32)	4.88 (124)	4.61 (117)		Input/Output* Stranded 20...10 AWG (0.5...4 mm ²) Solid 20...10 AWG (0.5...6 mm ²)
1606-XLE120EC					
1606-XLE120EE					
1606-XLE120EN					
1606-XLE240E	2.36 (60)	4.88 (124)	4.61 (117)		
1606-XLE240EE					
1606-XLE240EN					
1606-XLE240EP					
1606-XLE240F					
1606-XLERED					
1606-XLP15A	0.89 (22.5)	2.95 (75)	3.58 (91)	Input/Output* Stranded 20...10 AWG (0.5...4 mm ²) Solid 20...10 AWG (0.5...6 mm ²)	
1606-XLP15B					
1606-XLP15E					
1606-XLP25A	1.77 (45)	2.95 (75)	3.58 (91)		
1606-XLP30B					
1606-XLP30E					
1606-XLP36C					
1606-XLP50B					
1606-XLP50E					
1606-XLP50EZ					
1606-XLP50F					
1606-XLP72E					
1606-XLPRED					
1606-XLP90B	2.87 (73)	2.95 (75)	4.06 (103)	Input/Output* Stranded 28...12 AWG (0.3...2.5 mm ²) Solid 28...12 AWG (0.3...4 mm ²)	
1606-XLP90E-2					
1606-XLP95E					
1606-XLP100E					
1606-XLP100E-2					
1606-XLP100F					

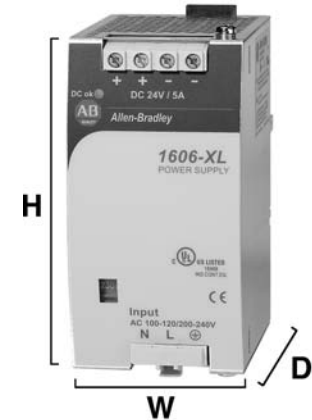

* Depth measurement does not include DIN Rail.

* The wire sizes indicated refer only to the connection capability of the terminal.

For proper operation, the correct wire size must be used (based on accurate determination of the electrical characteristics and loading of the system).

Bulletin 1606 Dimensions Table, Continued

Approximate dimensions are shown in inches (mm) unless otherwise indicated. Dimensions are not to be used for manufacturing purposes.

Catalog Number	W [in. (mm)]	H [in. (mm)]	D [in. (mm)]*	Wire Size* (Input and Output unless otherwise noted)
1606-XL60D	1.93 (49)	4.88 (124)	4.02 (102)	Input/Output* Stranded 20...10 AWG (0.5...4 mm ²) Solid 20...10 AWG (0.5...6 mm ²)
1606-XL180B	4.72 (120)	4.88 (124)	4.02 (102)	
1606-XL480E	8.6 (220)	4.88 (124)	4.02 (102)	
1606-XL480EP				
1606-XL480EPT				
1606-XL480GP				
1606-XL480F				
1606-XL120E-3	2.87 (73)	4.88 (124)	4.61 (117)	Input/Output* Stranded 20...10 AWG (0.5...4 mm ²) Solid 20...10 AWG (0.5...6 mm ²)
1606-XL240E-3	3.50 (89)	4.88 (124)	4.61 (117)	
1606-XL240E-3C	3.50 (89)	4.88 (124)	4.61 (117)	
1606-XL480E-3	8.66 (220)	4.88 (124)	4.02 (102)	
1606-XL480E-3W	5.91 (150)	4.88 (124)	4.76 (121)	
1606-XL480F-3H	8.66 (220)	4.88 (124)	4.02 (102)	
1606-XL720E-3	9.45 (240)	4.88 (124)	4.41 (112)	
1606-XL960E-3	10.83 (275)	4.88 (124)	4.61 (117)	Input* Stranded 20...10 AWG (0.5...4 mm ²) Solid 20...10 AWG (0.5...6 mm ²)
1606-XL960E-3S				Output* Stranded 22...8 AWG (0.5...10 mm ²) Solid 22...8 AWG (0.5...16 mm ²)
1606-XLS240-UPS	1.93 (49)	4.88 (124)	4.61 (117)	Input* Stranded 22...10 AWG (0.2...4 mm ²) Solid 22...10 AWG (0.2...6 mm ²) Output* Stranded 22...14 AWG (0.2...2 mm ²) Solid 22...14 AWG (0.2...2.5 mm ²)
1606-XLBUFFER	2.56 (65)	4.88 (124)	4.02 (102)	Input/Output* Stranded 20...10 AWG (0.5...4 mm ²) Solid 20...10 AWG (0.5...6 mm ²)
1606-XLDC40A	1.93 (49)	4.88 (124)	4.02 (102)	
1606-XLDNET4	2.56 (65)	4.88 (124)	4.02 (102)	
1606-XLDNET8	4.72 (120)	4.88 (124)	4.02 (102)	Input/Output* Stranded 22...10 AWG (0.2...2.5 mm ²) Solid 22...10 AWG (0.2...2.5 mm ²)
1606-XL60DR	1.93 (49)	4.88 (124)	4.02 (102)	Input/Output* Stranded 22...12 AWG (0.2...2.5 mm ²) Solid 22...12 AWG (0.2...2.5 mm ²)
1606-XL120DR	2.56 (64)	4.88 (124)	4.02 (102)	
1606-XL240DR	4.72 (120)	4.88 (124)	4.02 (102)	
1606-XLRED20-30	1.89 (48)	4.88 (124)	4.02 (102)	Input/Output* Stranded 20...10 AWG (0.5...4 mm ²) Solid 20...10 AWG (0.5...6 mm ²)
1606-XLRED40	1.89 (48)	4.88 (124)	4.61 (117)	

* Depth measurement does not include DIN Rail.

* The wire sizes indicated refer only to the connection capability of the terminal.

For proper operation, the correct wire size must be used (based on accurate determination of the electrical characteristics and loading of the system).



Accessories

1606-XLA Back of Panel Mounting Bracket for XL Power Supplies

Instead of snapping the power supply onto a DIN-rail, you also can mount it to the back of the panel. This set consists of two aluminum profiles which replace the existing profiles at the back of the unit.

Notes:

- You need one set per unit.
- In addition, two screws are required per set (e.g. M5 x 12 or corresponding sheet-metal screws; they are not included in the set.)

Approximate Dimensions (mm)

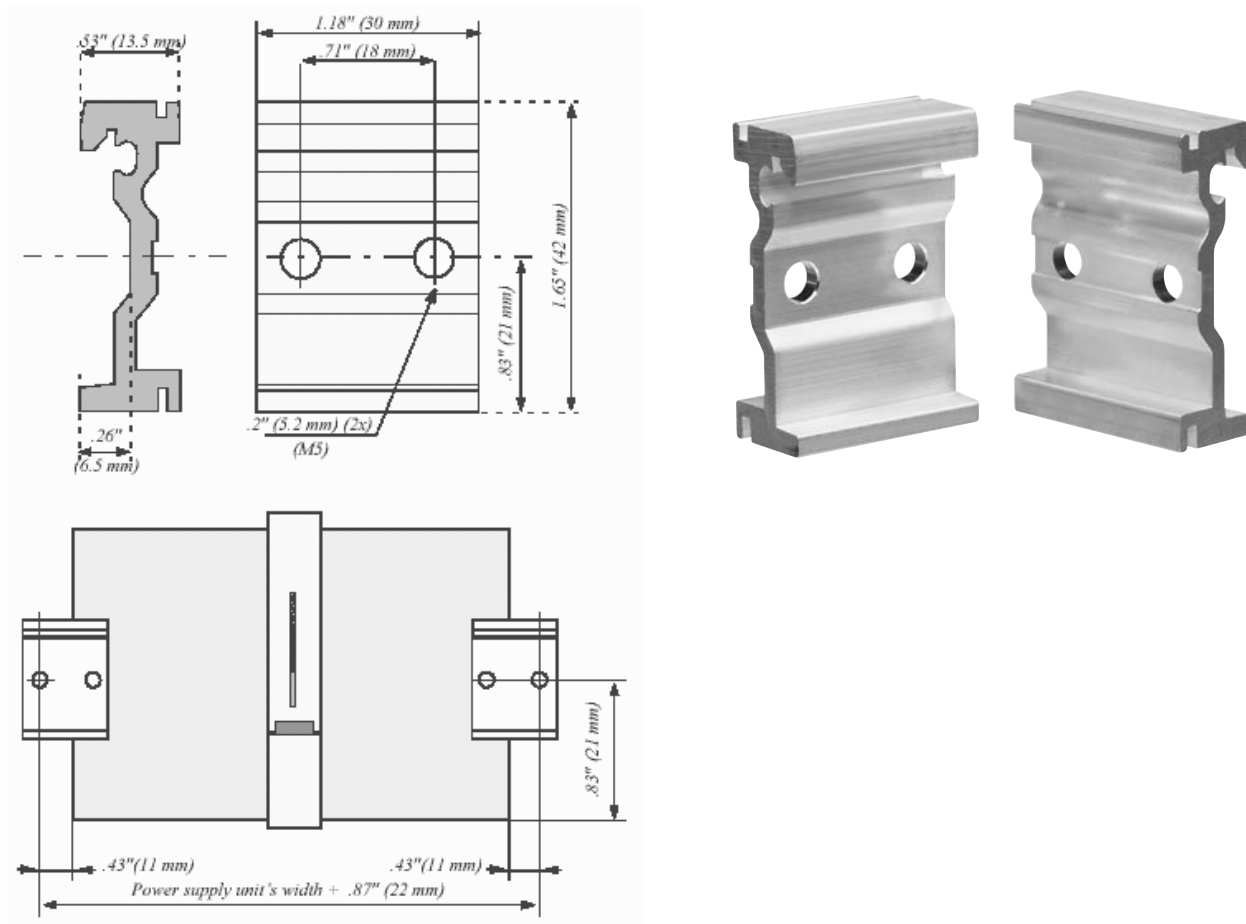

1606-XLB Back of Panel Mounting Bracket for XLS and XLE Power Supplies

Instead of snapping the power supply onto a DIN Rail, you can mount it to the back of the panel. This set consists of two steel brackets which replace the existing DIN Rail aluminum brackets at the back of the unit.

Note:

- You need one set per unit.

Approximate Dimensions (mm)

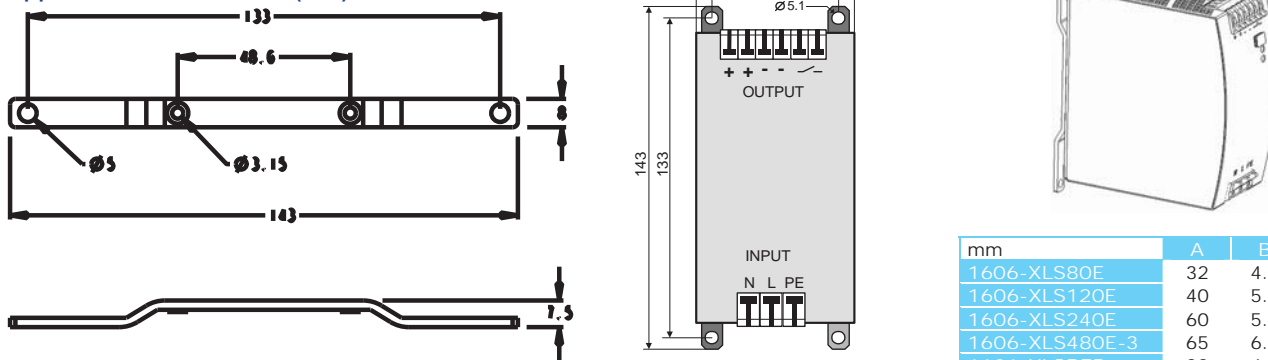

mm	A	B	C
1606-XLS80E	32	4.8	22.5
1606-XLS120E	40	5.3	29.5
1606-XLS240E	60	5.8	48.5
1606-XLS480E-3	65	6.3	40
1606-XLSRED	32	4.8	22.5

1606-XL Redundancy Capabilities

The 1606-XL family has two cost effective methods for providing redundancy to applications that are critical and can not risk failure.

1606-XL60DR, XL120DR and XL240DR Redundant Power Supplies

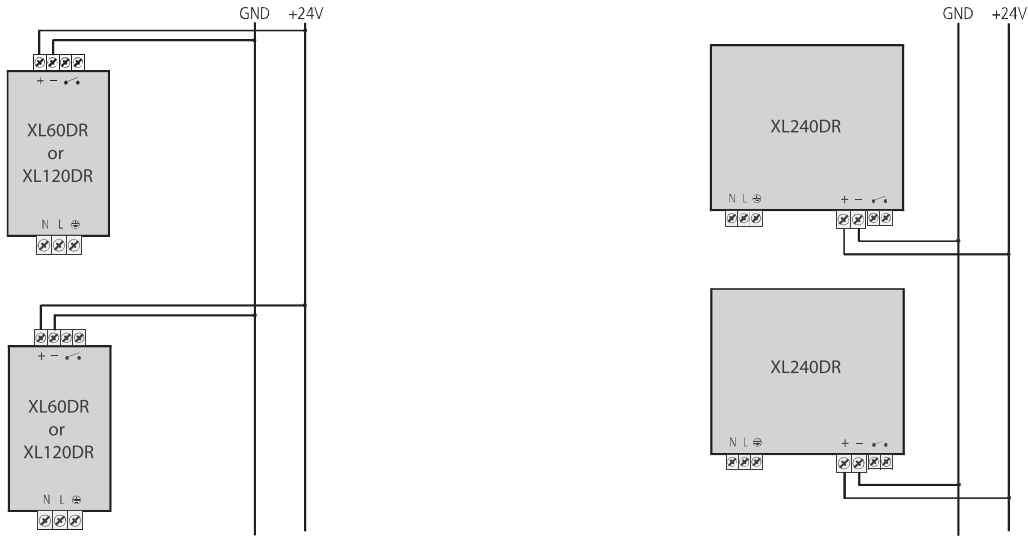

The 1606-XL60DR, XL120DR and XL240DR are enhanced versions of the standard power supplies.

- Each device has internal diodes which provide isolation against DC bus problems corrupting working supplies.
- Provides "DC OK" output relay to allow remote monitoring of DC power status.
- Utilizes pluggable terminals for easy installation.

1606-XLRED20-30 and 1606-XLRED40 Redundancy Modules

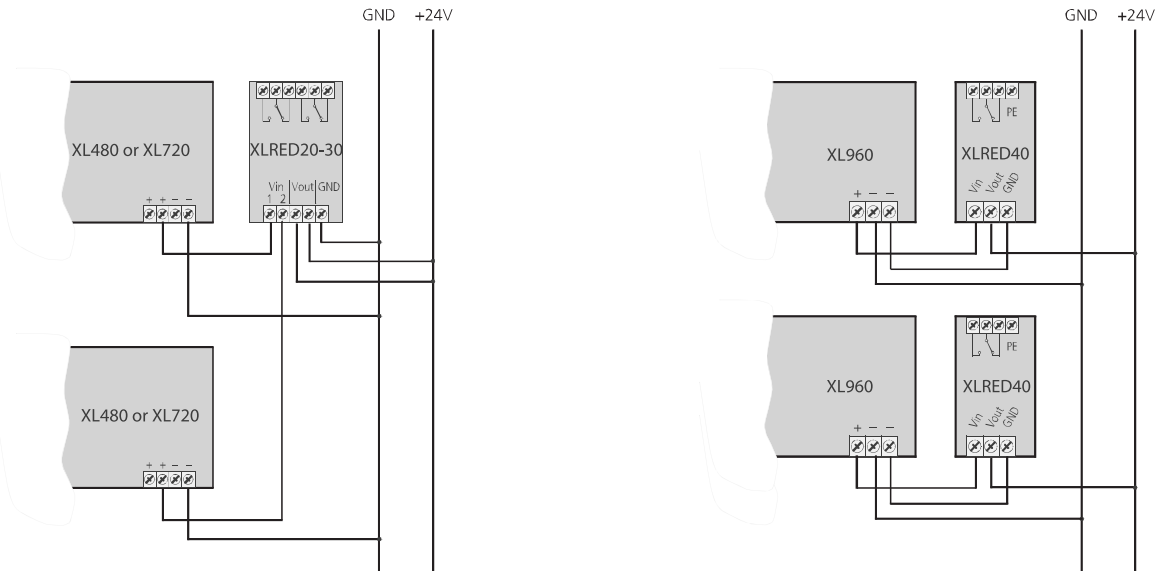

The 1606-XLRED20-30 and 1606-XLRED40 allow redundant wiring of 20...40 A power supplies.

- Devices provide isolation of power supplies via diodes.
- Provide remote monitoring of DC power status of each power supply.
- A single XLRED20-30 can be used per pair of identical 20 or 30 A power supplies.
- One XLRED40 is required for every 40 A power supply.

1606-XLPRED

- When used in 1 + 1 redundant systems (such as XLRED20-30) limited to 8 A (short circuit) per power supply
- When used in 1 + 1 redundant system (such as XLRED40) limited to 13 A (short circuit)
- See product technical data sheets for more application information.

1606-XLSRED/1606-XLERED

- When used in 1 + 1 redundant systems (such as XLRED20-30) limited to 10 A (short circuit) per power supply
- When used in 1 + 1 redundant system (such as XLRED40) limited to 20 A (short circuit)
- See product instruction manual for more application information.

1606-XLBuffer

Features

- Buffering for 24V loads
- Guaranteed hold-up time: 0.2 s/20 A...3.6 s/1 A
- Fit for industrial use: Energy storage in electrolytic caps., no accumulators
- Clear status indication by Status LED and signalling terminals
- No batteries requiring replacement

Short Description

The buffer unit is a supplementary device for regulated 24V DC power supplies. It buffers load currents during typical mains faults and switching events or load peaks.

Working principle

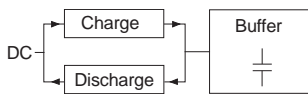

In times when the power supply provides sufficient voltage, the buffer unit stores energy in integrated electrolytic capacitors. In case of a mains voltage fault, this energy is released again in a regulated process.

Bridges mains faults without interruption

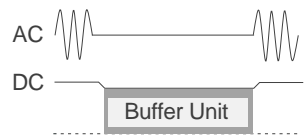

Statistics show that 80% of all mains faults last less than 0.2 s. These mains faults are completely bridged by the buffer unit and will have no influence on the DC power. This increases the reliability of the system as a whole.

Extended hold-up time

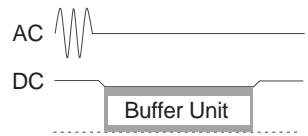

Once the main power fails or is switched off, the buffer unit will continue to provide the load current for a defined period of time. Process data can be saved and processes can be terminated before the DC power switches off. Controlled restarts are subsequently possible.

Easy to handle, expandable, and maintenance-free

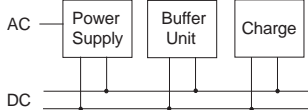

The buffer unit does not require any control wiring. It can be added in parallel to the load circuit at any given point. Any given number of buffer units can be installed in parallel to increase the output capacity or the hold-up time. The dual terminals allow for easy wiring.

Operating Modes

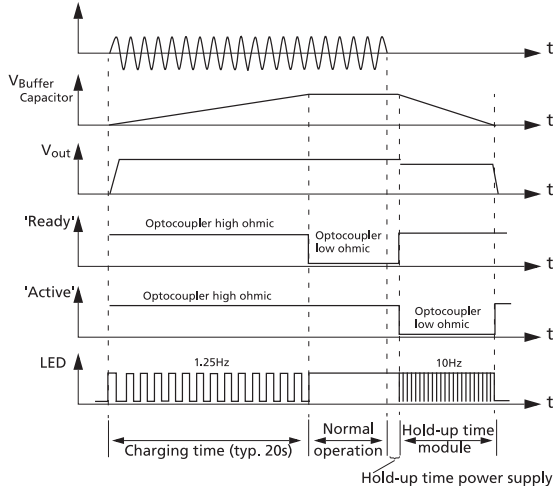

Activation Threshold

"22.5V fixed"	Buffering starts if terminal voltage <22.5V, voltage is kept at 22.5V.
"Vin -1V"	Buffering starts if terminal voltage decreases by more than 1V, faster than typ. 0.54V/s. Voltage is kept at that level. Buffering ends when voltage increases once more by 1V.
Noise (spikes)	>200 mV _{PP} (20 MHz bandw., 50 Ω measurement, buffer operation only)
Over voltage protection	limited to max. ±35V

Hold-up Time

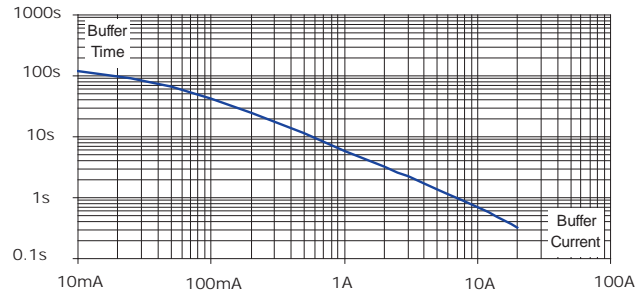

Operating Indicators and Elements

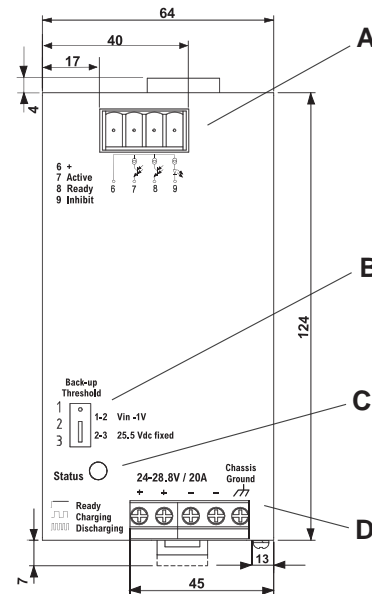

A - Signaling terminals:

- 7 Active: unit is buffering
- 8 Ready: unit is on stand-by
- 9 Inhibit: Initiates buffer discharging, inhibits recharging of capacitor array

C - Status LED

Indicates charge status of buffer capacitor array

B - Jumper back-up threshold:

- Position 1-2: variable: Vin -1V. Buffering if voltage decreases faster than typical 0.54V/s and greater than 1V
- Position 2-3: DC 22.5V fixed. Voltage buffering starts at Vin less than 22.5V

D - Power In/Out terminals:

- dual terminals
- + (positive)
- - (negative)
- Housing connection 'chassis ground'

1606-XLS DC UPS

Features

- Requires only one 12V battery
- Flexible battery options, modular system
- Regulated output voltage in buffer mode
- 50% power reserves

- Electronically protected against output overloads
- Extensive battery management including battery quality and installation tests
- Soft charger for optimum battery life
- Extensive diagnostic and monitoring functions

Short Description

The DC UPS is a supplementary device to a 24V power supply. It provides back-up power to bridge dips, sags, or brief losses of power using a 12V battery. Based on the battery you select, you can achieve hold-up times anywhere from a few minutes to several hours.

Working principle

In times when the power supply provides sufficient voltage, the DC UPS charges the 12V battery. When input power fails, the battery voltage will be boosted to a 24V level through a boost converter and the energy will be released in a regulated process to the load.

Integrated in the DC UPS is a sophisticated battery management system. This battery management system incorporates a battery charger, deep discharge protection, and overload protection which together increase the service life of the battery.

In addition, there are extensive protective features that self-protect the unit from damage along with diagnostic and monitoring functions that aid in troubleshooting.

Extended hold-up time

The modular design of the DC UPS allows for flexible battery options. The design will accept valve regulated, lead-acid batteries between 3.9Ah – 27Ah. The modularity of the system enables you to match the battery with your application requirements.

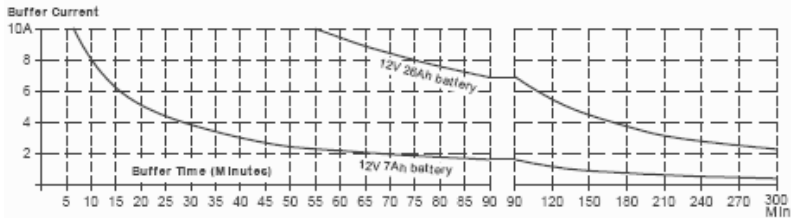
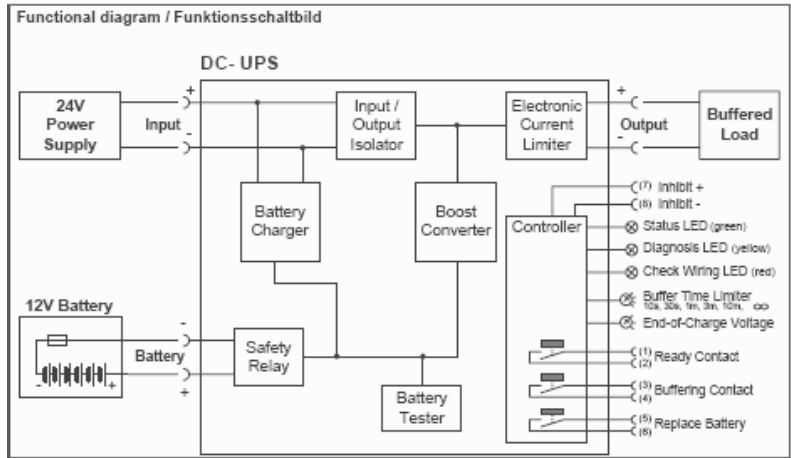

Extensive Diagnostic & Monitoring Functions Protective Features:

- Wrong battery voltage (24V instead of 12V)
- Wrong battery polarity
- Too high ambient temperature
- Output overload or output short-circuit

- Deep discharge (battery) protection
- Wrong polarity on input terminals
- Over-voltage protection (malfunctioning of the internal regulation loops)

A - Status LED (green):

- Ready: Battery is charged > 85%, no wiring failure is recognized, input voltage is sufficient and inhibit signal is not active.
- Charging: Battery is charging and battery capacity is below 85%.
- Buffering: Unit is in buffer mode.

D - Adjustor:

- Buffer time limiter: User accessible switch which limits the maximum buffer time in a buffer event, to save battery capacity.
- End-of-charge voltage: User accessible potentiometer which sets the end-of-charge voltage. Adjust the potentiometer according to the expected battery temperature.

B - Diagnosis LED (yellow):

- Overload: Output has switched off, due to long overload in buffer mode or due to high temperatures.
- Replace battery: Indicates a battery which failed the battery quality test (SCH test). Battery should be replaced soon.
- Buffer time expired: Output has switched off due to settings of buffer time. The signal will be stored and displayed for 15 minutes.
- Inhibit active: Indicates that buffering is disabled due to an active inhibit signal.

E - Signal contacts:

Ready (contact 1-2):

Contact is closed when battery is charged more than 85%, no wiring failure is recognized, input voltage is sufficient, and inhibit signal is not active.

Buffering (contact 3-4):

Contact is closed when unit is buffering.

Replace battery (contact 5-6):

Contact is closed when input voltage is sufficient and battery quality test (SCH test) indicates a negative result, three times in a row.

Inhibit input (contact 7&8):

The inhibit input disables buffering. In normal mode, a static signal is required. In buffer mode, a pulse with a minimum length of 250 ms is required to stop buffering. The inhibit is stored and can be reset by cycling the input voltage.

C - Check wiring LED (red):

Check wiring between DC UPS and battery, as well as the battery itself. Also indicates when input voltage is not in range.

